



TS2501 Wi-Fi Smart Thermostat

# Installation Guide



## Table of Contents

<b>1</b>	<b>Welcome</b>	<b><a href="#">3</a></b>
<b>2</b>	<b>Preparation</b>	<b><a href="#">4</a></b>
	- What's in the box?	<a href="#">4</a>
	- Tools needed for installation	<a href="#">5</a>
	- Accessories (Sold separately)	<a href="#">5</a>
	- Quick Start Guide for Homeowner Installation	<a href="#">6</a>
	- Quick Start Guide for Contractor Installation	<a href="#">7</a>
<b>3</b>	<b>Thermostat Features</b>	<b><a href="#">8</a></b>
<b>4</b>	<b>Thermostat LCD Display</b>	<b><a href="#">9</a></b>
<b>5</b>	<b>Let's Get Started!</b>	<b><a href="#">10</a></b>
	- Precautionary measures	<a href="#">10</a>
	- Good installation practices	<a href="#">12</a>
	- With or without C-Wire	<a href="#">13</a>
<b>6</b>	<b>Installation With a C-Wire</b>	<b><a href="#">14</a></b>
<b>7</b>	<b>Installation Without a C-Wire</b>	<b><a href="#">27</a></b>
<b>8</b>	<b>Start-Up Configuration</b>	<b><a href="#">47</a></b>
	- Online Start-Up Configuration using Wi-Fi Connection	<a href="#">48</a>
	- Offline Start-Up Configuration without using Wi-Fi Connection	<a href="#">49</a>
<b>9</b>	<b>Wiring Diagrams</b>	<b><a href="#">54</a></b>
<b>10</b>	<b>Troubleshooting</b>	<b><a href="#">61</a></b>
<b>11</b>	<b>Legal</b>	<b><a href="#">62</a></b>
<b>12</b>	<b>Warranty</b>	<b><a href="#">64</a></b>



## Welcome!

Thank you for choosing the TrickleStar® TS2501 Wi-Fi Smart Thermostat™.

We are your smart partner in optimizing comfort and maximizing savings for your Heating, Ventilation, and Air Conditioning (HVAC) systems. You can now remotely control and monitor the heating and cooling systems in your home and business from anywhere.

If you have any inquiries about TrickleStar products or need technical support, visit our website for tutorials, videos and Frequently Asked Questions (FAQ). You can also contact us by email or phone.

Website: [www.tricklestar.com](http://www.tricklestar.com)

Email: [customer.service@tricklestar.com](mailto:customer.service@tricklestar.com)

Toll Free: 1-888-700-1098

## Instruction Videos

If you want to see the Installation Instructions as videos, visit our YouTube channel:

<https://www.youtube.com/user/TrickleStarUS/>



## Preparation

### What's in the box?

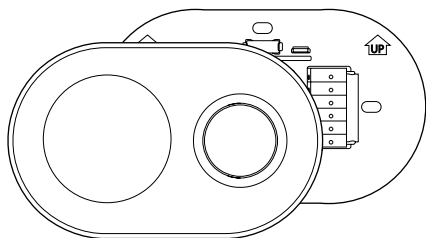

Thermostat with Mounting Plate

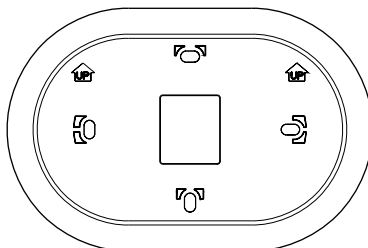

Trim Plate

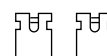

Extra jumpers

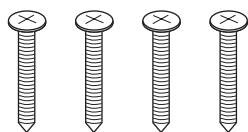

Screws (4 pcs)

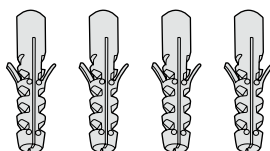

Drywall plugs (4 pcs)

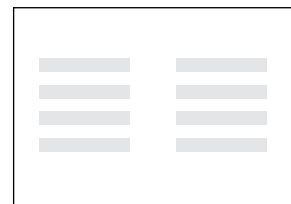

Wire labels

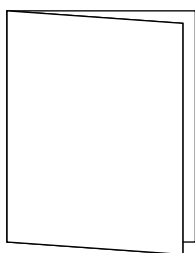

Quick Start Guide

## Tools needed for installation

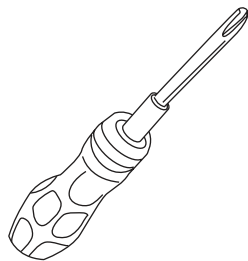

Phillips screwdriver

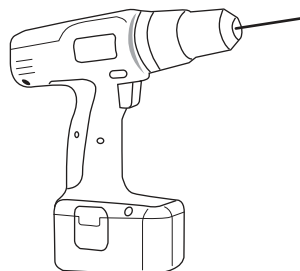

Drill with 3/16 in. (3.3 mm) drill bit

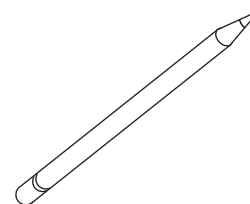

Pencil

Mobile devices with 2.4 GHz Wi-Fi connection (to access to TrickleStar Portal):

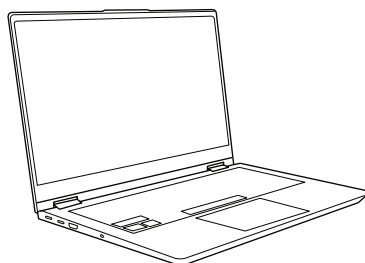

Laptop

or

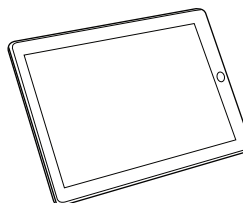

Tablet

or



Smartphone

## Accessories (Sold separately)

For more information on these accessories, scan the QR code or visit our website at: [www.tricklestar.com](http://www.tricklestar.com)

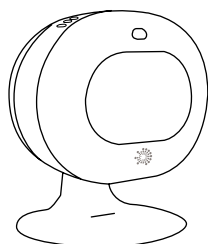

TS1921 Occupancy Sensor

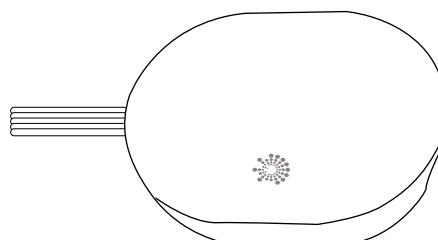

TS2104 C-Wire Adapter



## Quick Start Guide for Homeowner Installation

Before you start the installation, be sure to check the Thermostat compatibility and create a Portal account.



### A. Check compatibility

- Is the TrickleStar Thermostat compatible with your HVAC system?
- Is the C-Wire Adapter needed?

<https://portal.tricklestar.com/tstat/compatibility>

### B. Create and log in to Portal

Create a Portal account using the QR code or through the website: [portal.tricklestar.com](https://portal.tricklestar.com)

Then, log in to the Portal.



### C. Add your device and start the Thermostat Setup Wizard

Follow the step-by-step guide to install the Thermostat.

---

## Installation Workflow

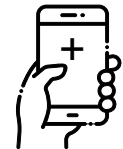
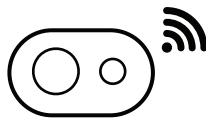

### Step 1

Install the TrickleStar Thermostat.

### Step 2

Connect the Thermostat to Wi-Fi via the Portal

### Step 3

Select the settings for the Thermostat.

### Step 4

Add the TrickleStar App on homeowner's smartphone. (Optional)

## Quick Start Guide for Contractor Installation

Before you start the installation, be sure to check the Thermostat compatibility and create a Portal account.

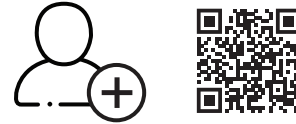

### A. Check compatibility

- Is the TrickleStar Thermostat compatible with your HVAC system?
- Is the C-Wire Adapter needed?

<https://portal.tricklestar.com/tstat/compatibility>

### B. Create and log in to Portal

Create a Portal account using the QR code or through the website: [portal.tricklestar.com](https://portal.tricklestar.com)

Then, log in to the Portal.



### D. At Thermostat Setup Wizard, create a new site for homeowner

Create a new site to easily transfer ownership of the Thermostat to homeowner.

### C. Add your device and start the Thermostat Setup Wizard

Follow the step-by-step guide to install the Thermostat.

## Installation Workflow

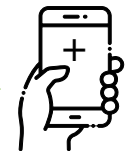
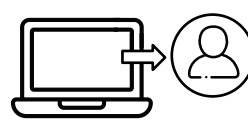
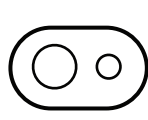

### Step 1

Install the TrickleStar Thermostat.

### Step 2

Connect the Thermostat to Wi-Fi via the Portal

### Step 3

Select the settings for the Thermostat.

### Step 4

Transfer ownership to homeowner.

### Step 5

Add the TrickleStar App on homeowner's smartphone. (Optional)

## Thermostat Features

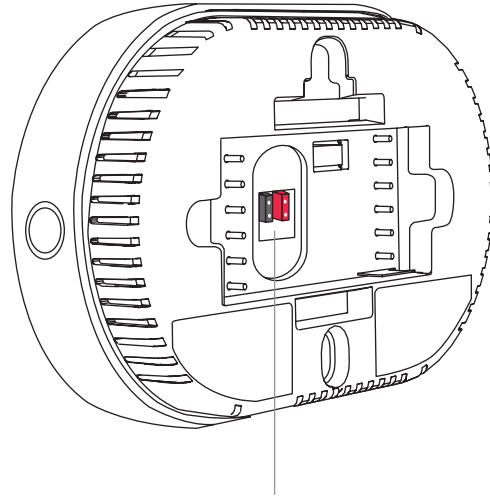
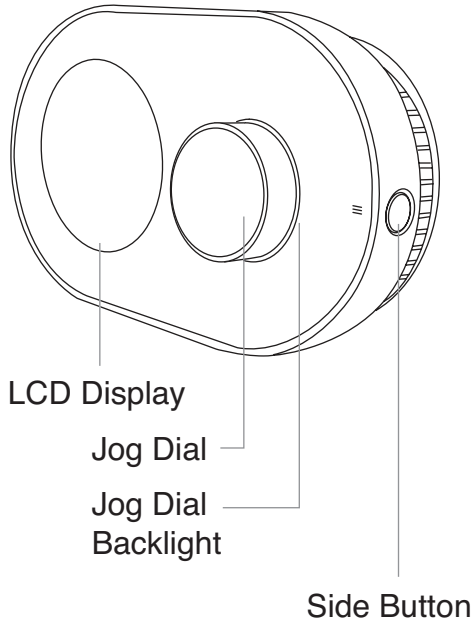

Jumper (Black & Red)  
 - Black: ACC wires settings  
 - Red: RH wire settings

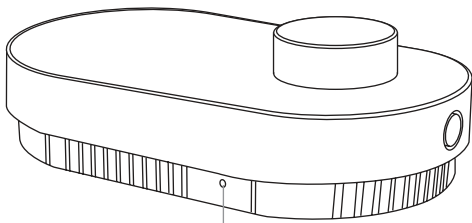

Main Unit

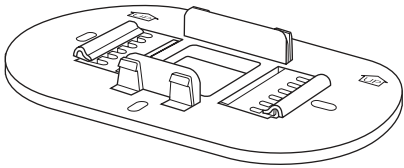

System Reset Pinhole  
 Mounting Plate

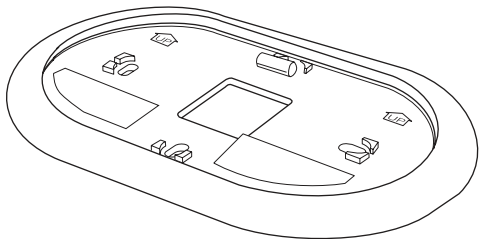

Trim Plate

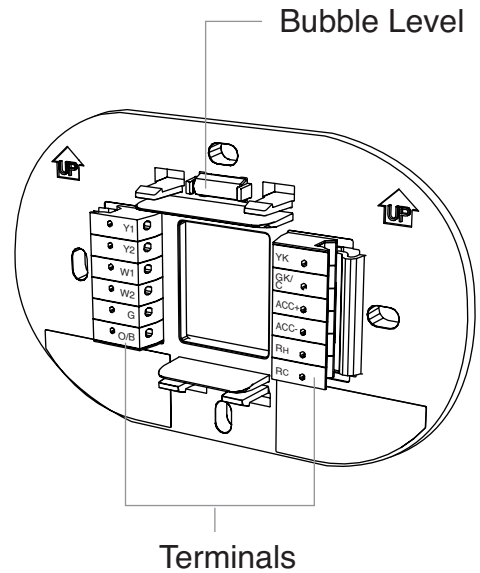



## Thermostat LCD Display



### Setpoint Temperature Speedometer



**Home Indicator**  
Mode: Home



**Away Indicator**  
Mode: Away



**Sleep Indicator**  
Mode: Sleep



**Off Indicator**  
System: Off



**Heat Indicator**  
System: Heat



**Cool Indicator**  
System: Cool



**Auto Indicator**  
System: Auto



**E.Heat Indicator**  
System: Emergency Heating



**Fan On Indicator**  
Fan: On



**Fan Auto Indicator**  
Fan: Auto



**Wi-Fi Indicator**  
Indicates Wi-Fi connection and signal strength.  
Flashes rapidly: Wi-Fi is disconnected.  
Flashes slowly: Connection to Portal is lost.



**Bluetooth Indicator**  
When connected to one or more occupancy sensors.  
Flashes: Thermostat is scanning for occupancy sensor



**Key-Lock Indicator**  
Indicates the input is locked.  
Flashes: Reminds users that the Thermostat input is locked when new input is detected.



**Hold Indicator**  
Indicates Permanent Hold / Vacation Hold.  
Flashes: Temporary Hold



**Schedule Indicator**  
Indicates a schedule is in progress

58%

**Humidity Indicator**  
Display the room humidity in percentage

79

**Room Temperature Indicator**  
Display the room temperature

74

**Setpoint Temperature Indicator**  
Display the setpoint temperature

TrickleStar

**TrickleStar Logo**  
Brand (Always on)

## Let's get started!

### Precautionary measures

- Read all instructions carefully before starting the installation.
- Before installing the Thermostat, be sure to turn off the power for your HVAC system either at the Circuit Breaker Box or at the Main Switch.
- Leave the power OFF until you have finished the installation.

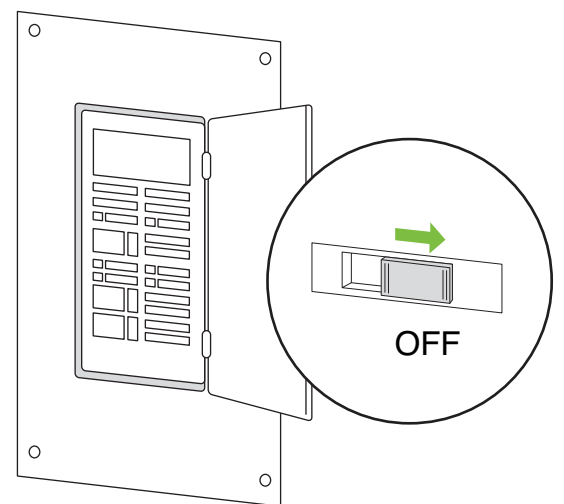
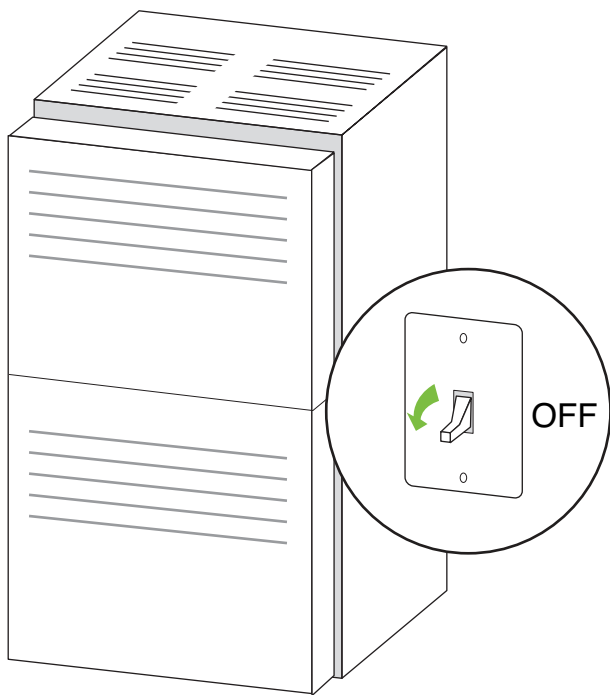

*Hint: Your system should not make any noise and you should not feel any air exiting your vents when the power is OFF.*

- Remove the front cover of your old thermostat from its base.
- Your system is not compatible with the TrickleStar Thermostat if you see:
  - thick black wires with wire nuts.
  - the base on the old thermostat has “L1” and “L2” on the terminal blocks.
  - “120 - 240 V AC” or “High Voltage” labels.
- The TrickleStar Thermostat is **ONLY** designed for 24 V AC with a total switching current of 3 A maximum.

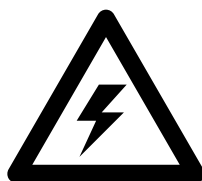
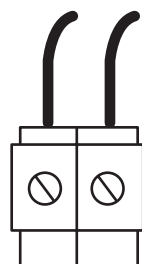
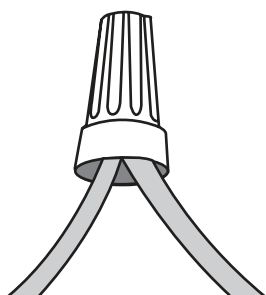
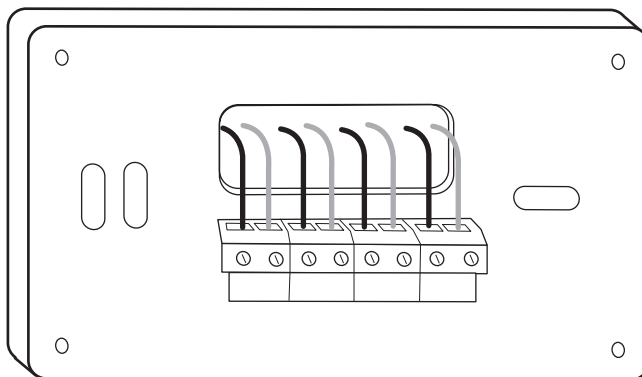

120-240 V AC/  
High voltage

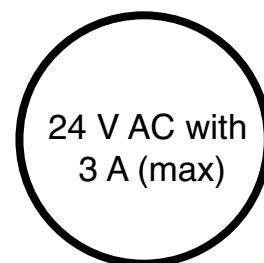

*Alert: If you have any doubts about installing the Thermostat, contact a professional contractor.*

## Good installation practices

Before you start the installation, we recommend that you take a photo of the label attached at the bottom of your Thermostat. You may need to refer to this information when you connect your Thermostat to Wi-Fi via the TrickleStar Portal.

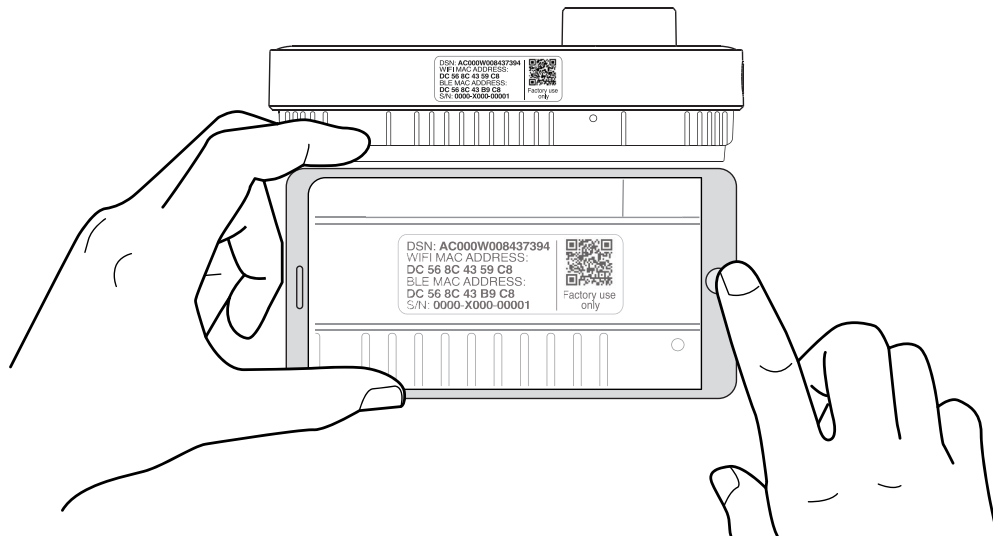

After removing the front cover of your old thermostat from its base, we recommend that you take a photo of the wires connected to the terminals at the base. You may need to refer to this photo at a later stage.

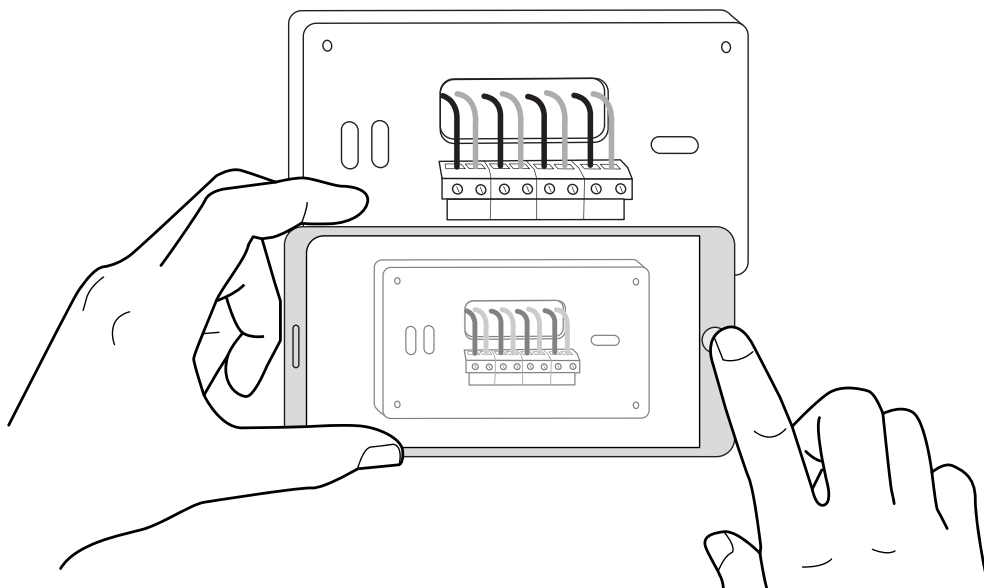

## With or without C-Wire?

The TrickleStar Thermostat supports installation for both with and without C-Wire, but the installation is a little different.

Do you have a C-Wire connected to your old thermostat? Check the wires connected to the terminals on the base of your old thermostat.

- If a wire is connected to the “C” terminal, then your system has a C-Wire to power your new TrickleStar Thermostat.
- If there is no wire connected to the “C” terminal, then you need to install a C-Wire Adapter to power your new TrickleStar Thermostat.

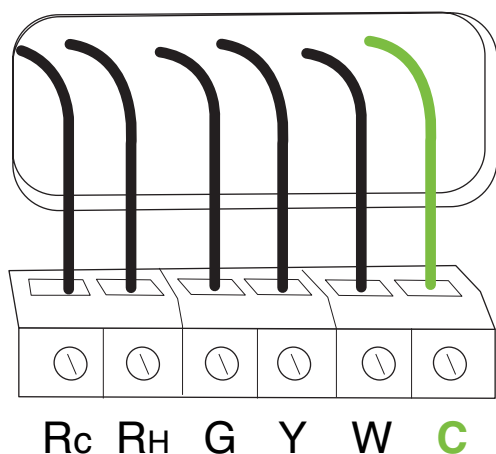

Yes, with C-Wire.  
Continue to page 13.

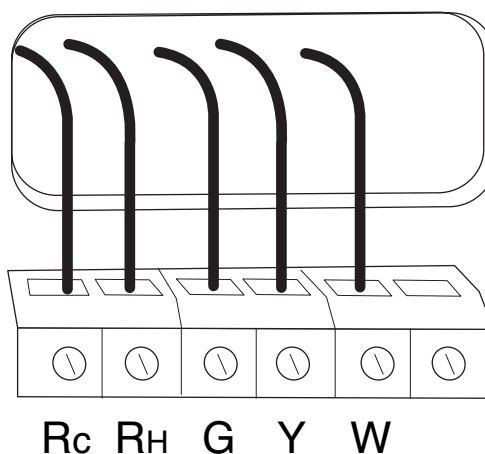

No, without C-Wire.  
Continue to page 27.



*Note: Make sure that the C-Wire at your old thermostat is directly connected to the HVAC Control Board.*

## Installation With a C-Wire

If your system has a C-Wire, it will power your new TrickleStar Thermostat. You do not need a C-Wire Adapter (sold separately as an accessory).

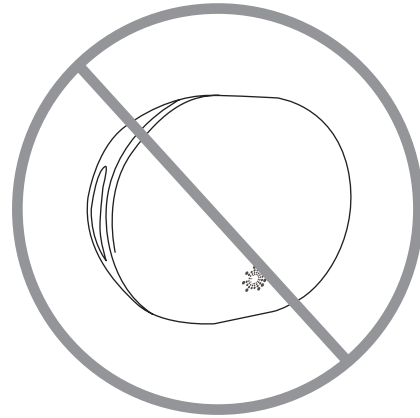

### Step 1: Disconnect and label old thermostat wires

Disconnect and label the wires from your old thermostat carefully, one wire at a time, using the wire labels provided.

Make sure the wires do not fall back into the wall when released from the terminals and that the labels are fastened to the wires securely.

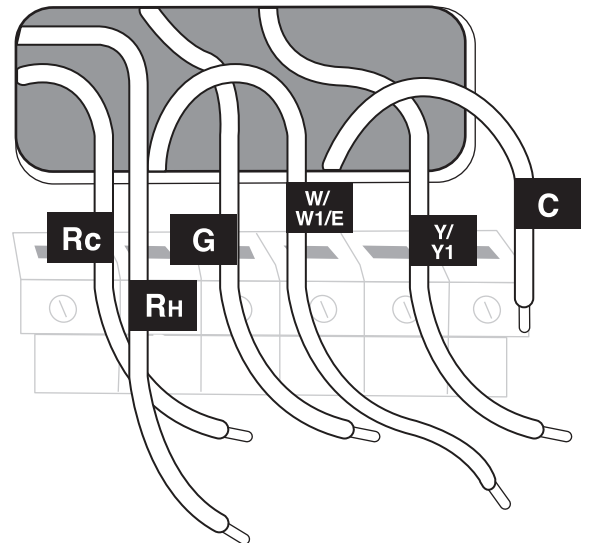

*Note: Make sure that the C-Wire at your old thermostat is directly connected to the HVAC Control Board.*

## Step 2: Remove old jumper wire

If the terminals on your old thermostat has a jumper wire between RH, RC or R, remove the jumper wire. Your new TrickleStar Thermostat does not need this jumper wire.

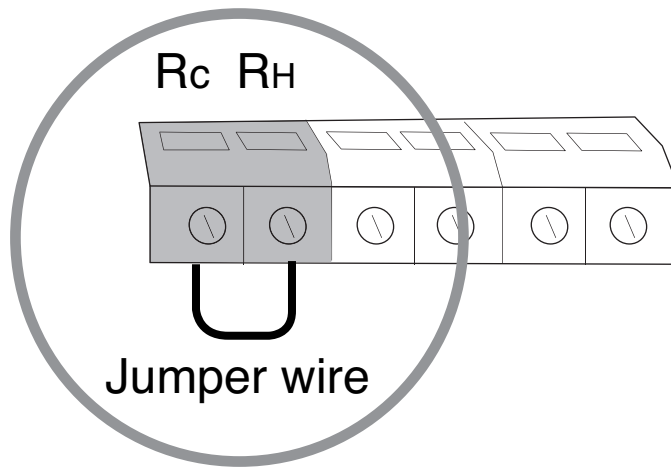

## Step 3: Unscrew old Mounting Plate

Unscrew the Mounting Plate of your old thermostat to remove it from the wall. When you remove the Mounting Plate, be sure not to tear off the labels on the wires.

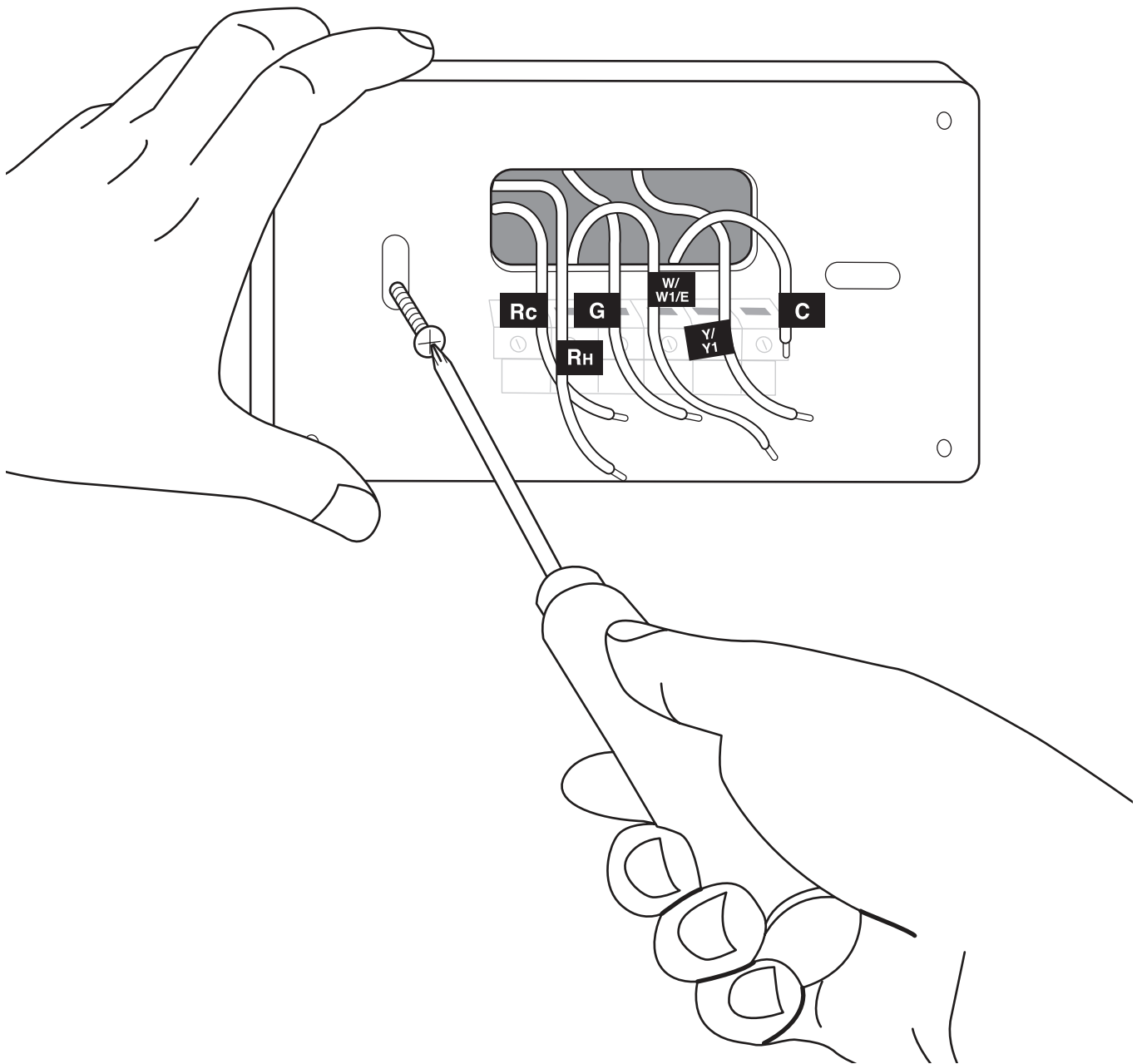



## Step 4: Replace with new Thermostat Mounting Plate

Decide if you want to mount the TrickleStar Thermostat directly to the wall via the Mounting Plate or you want to use the Trim Plate. The Trim Plate helps you to hide marks or holes left on the wall by your old thermostat.

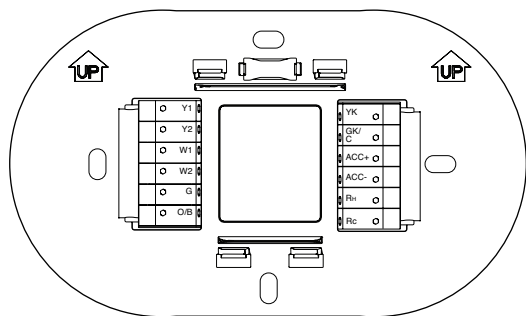

Mounting Plate

OR

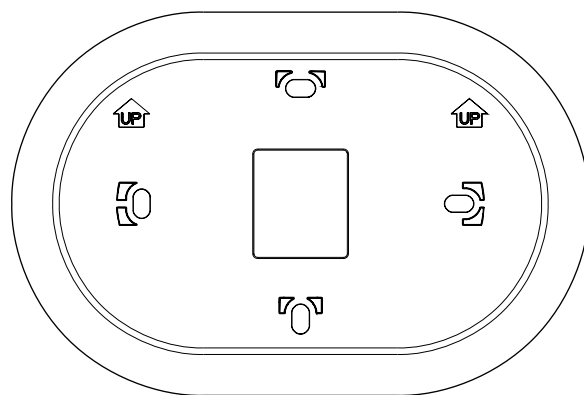

Trim Plate

## Step 5: If the Trim Plate is used (Optional)

If you use the Trim Plate, align the mounting holes on the Trim Plate and Mounting Plate, then press them together into place.

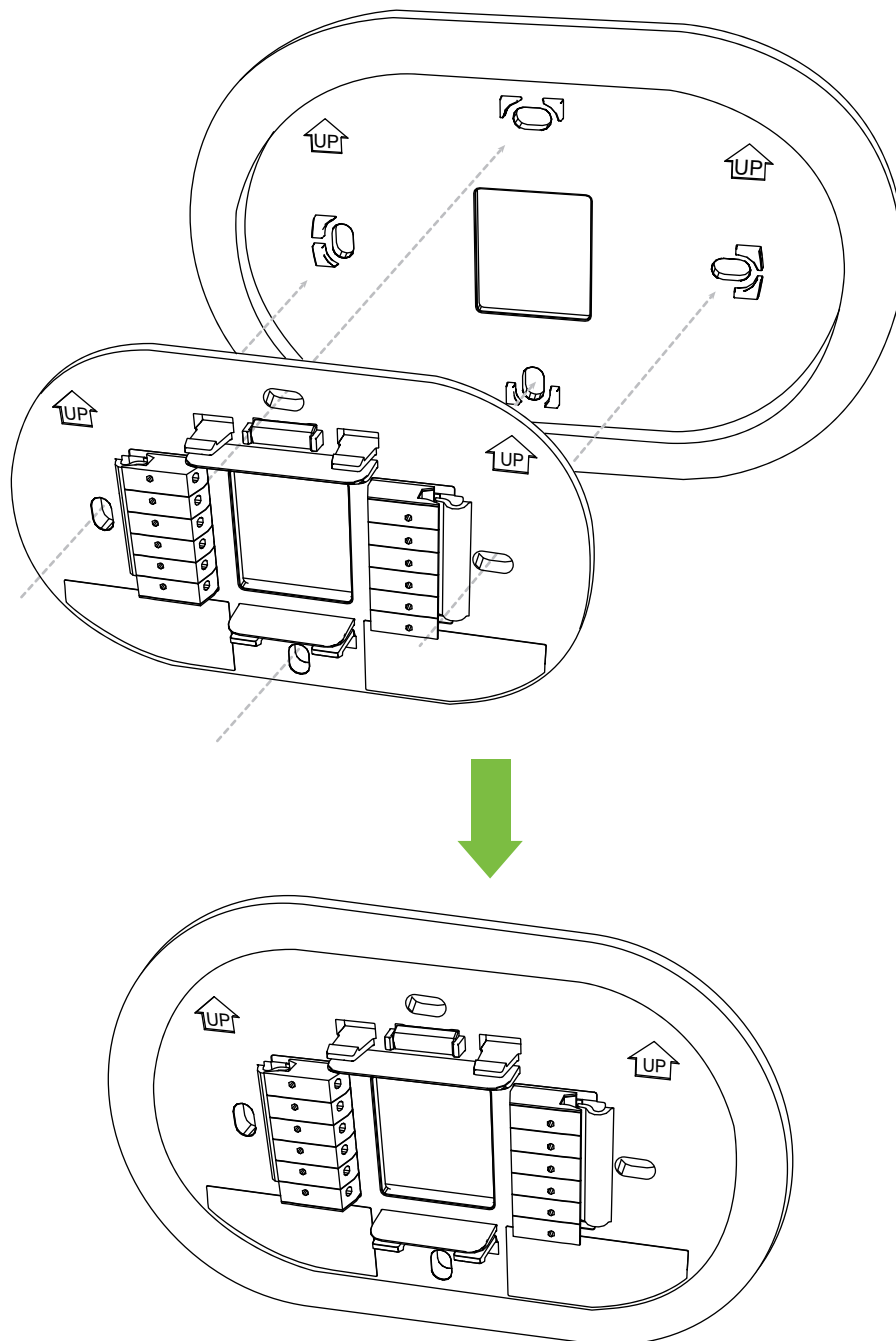

## Step 6: Pull the labeled wires through the hole of the Mounting Plate

Pull the labeled wires carefully through the hole of the Mounting Plate.

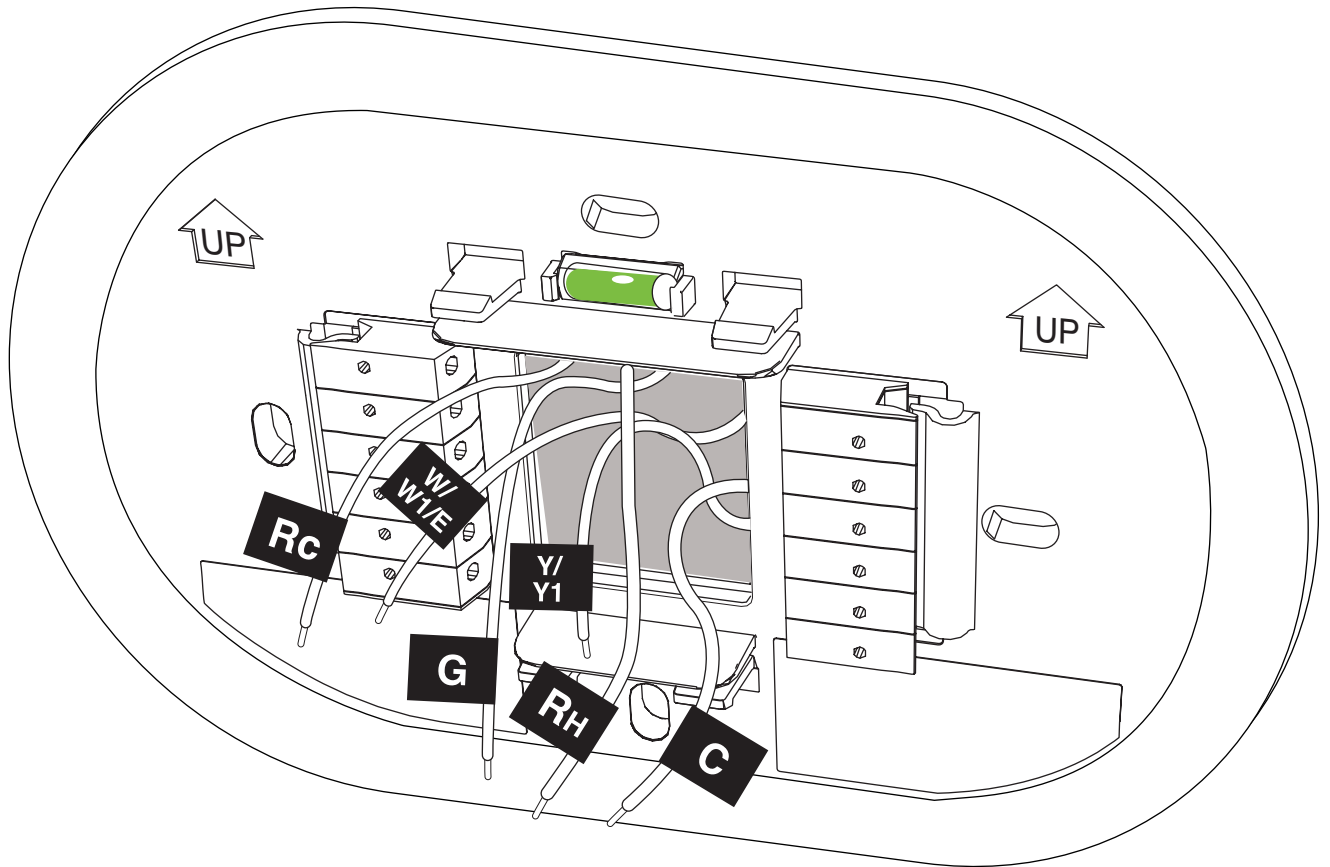

## Step 7: Attach the Mounting Plate on the wall

Attach the Mounting Plate on the wall using the drywall plugs and screws provided. Use the built-in bubble level to make sure the base is level.

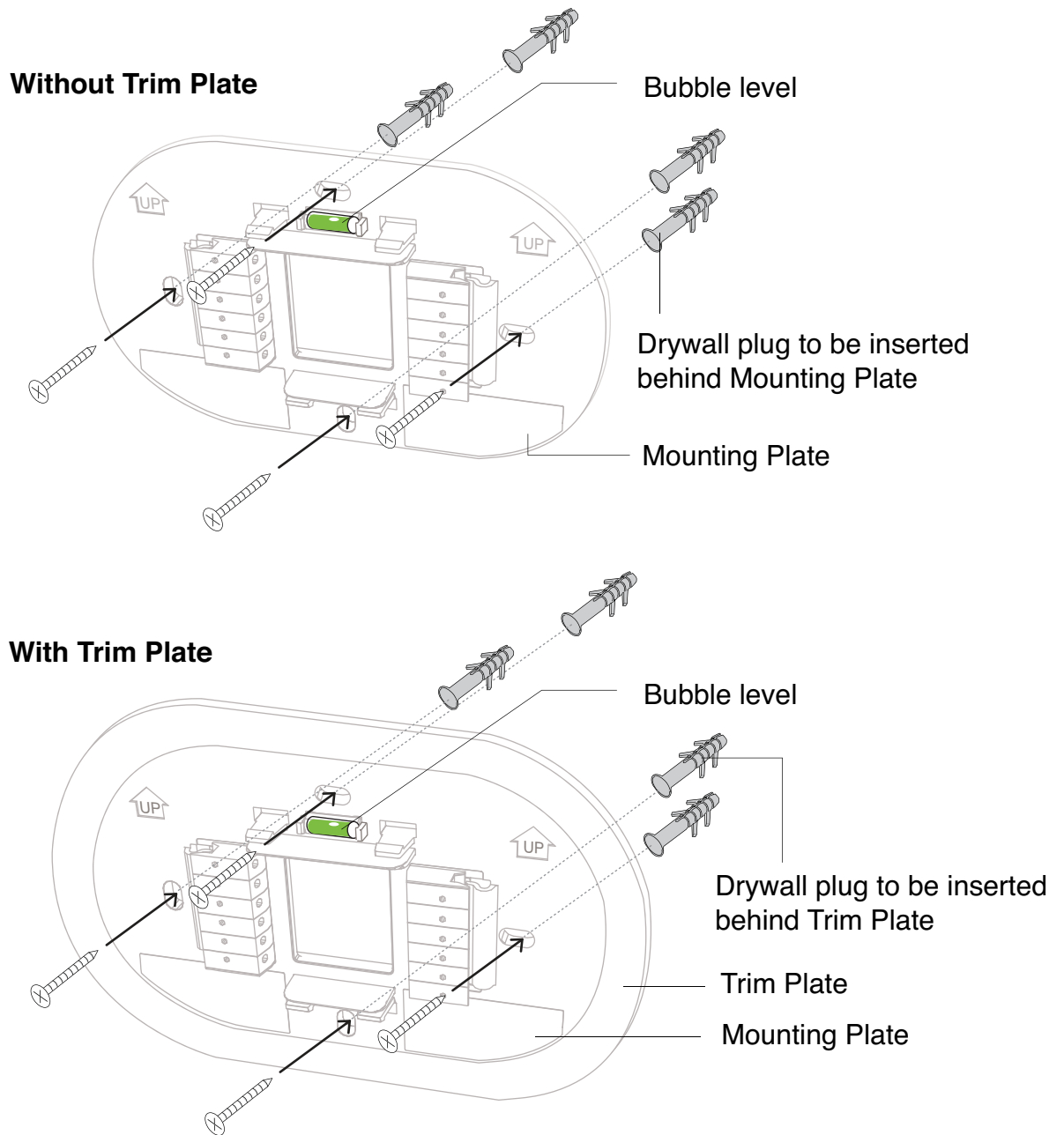

## Step 8: Connect the wires

Connect the labeled wires to their corresponding terminals on the Thermostat Mounting Plate.

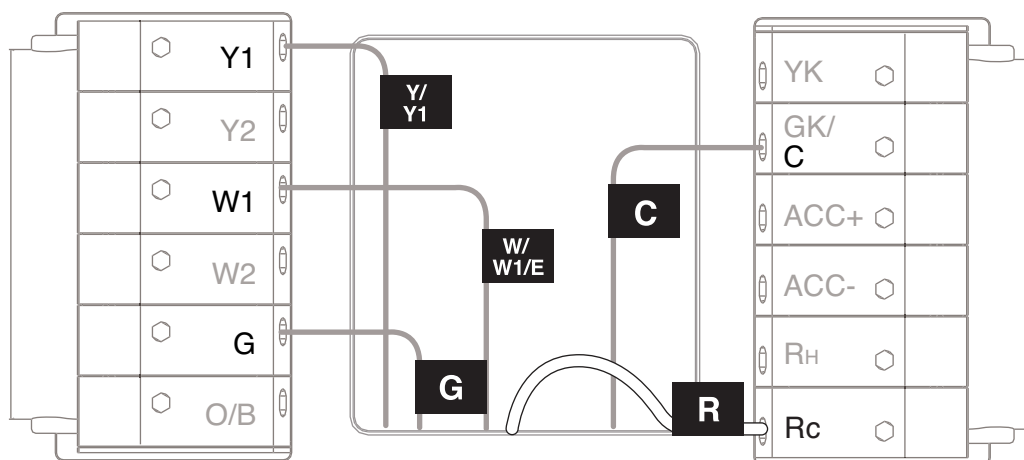

Connect the R or RC wire to the RC terminal.

Do you have more than one R wire? (That includes R, Rc, and RH)

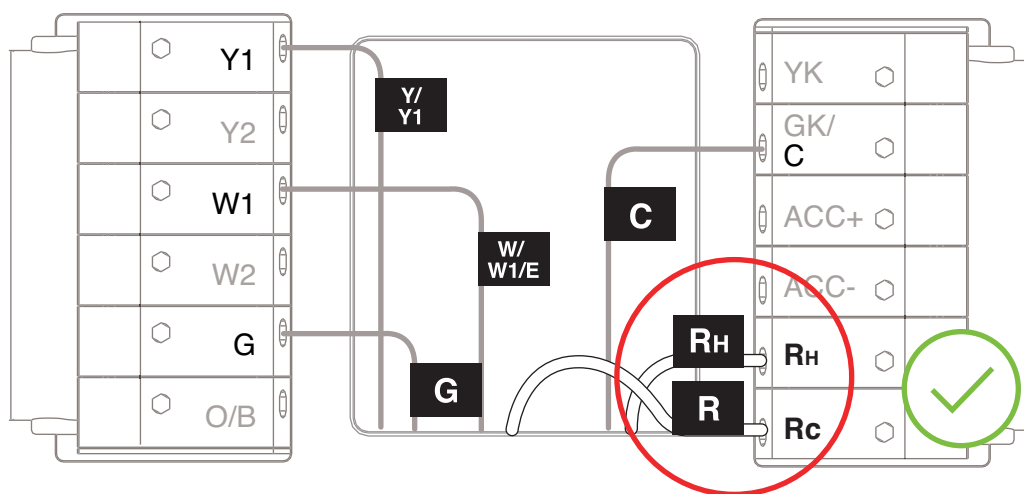

Connect the R or RC wire to the RC terminal and the RH wire to the RH terminal.

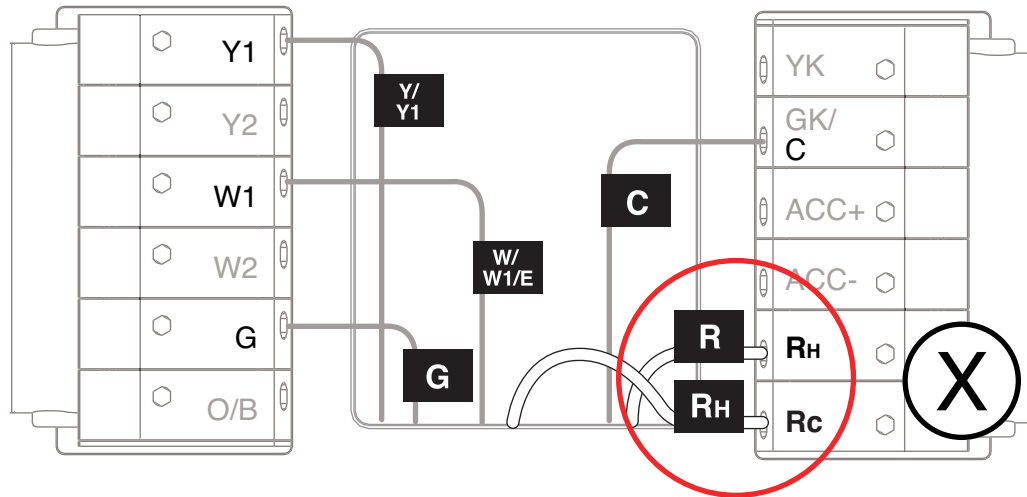

Do not connect the R or RC wire to the RH terminal or the RH wire to the RC terminal.



**Note:**

- You can refer to “Wiring Diagrams” from pages [54](#) to [59](#) for some common HVAC equipments.
- Connect any remaining wires to their corresponding terminals. Pull the wires gently to ensure that they are connected securely.
- Tape the ends of any excess wires and push the wires back into the wall carefully.
- Make sure there is no draft coming from the hole in the wall as it may affect the temperature readings.

## Step 9: Set the jumpers on the back of your Thermostat

Accessory wires on the thermostat (ACC+ and ACC-) are used to power devices such as a humidifier or a dehumidifier. If your HVAC system does not have any accessory wires, you can leave the black jumper in either position.

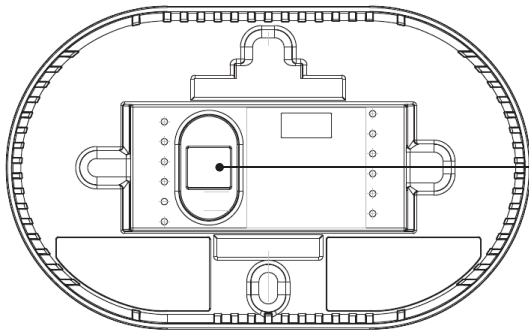

**⚠ Jumper Position for Accessory & RH Wire**

<b>2 ACC wires with RH Wire (Default position)</b>	<b>2 ACC wires without RH wire</b>	<b>1 ACC wire with RH wire</b>	<b>1 ACC wire without RH wire</b>

ACC wire  
 RH wire

**Note :** If there is no ACC wire, the black jumper can be in either position.

If your Accessory item has two wires, and your HVAC system has an RH wire, set jumpers as illustrated. This is the default position.

If your Accessory item has two wires, and your HVAC system does not have an RH wire, set jumpers as illustrated.

If your Accessory item has one wire, and your HVAC system has an RH wire, set jumpers as illustrated.

If your Accessory item has one wire, and your HVAC system does not have an RH wire, set jumpers as illustrated.

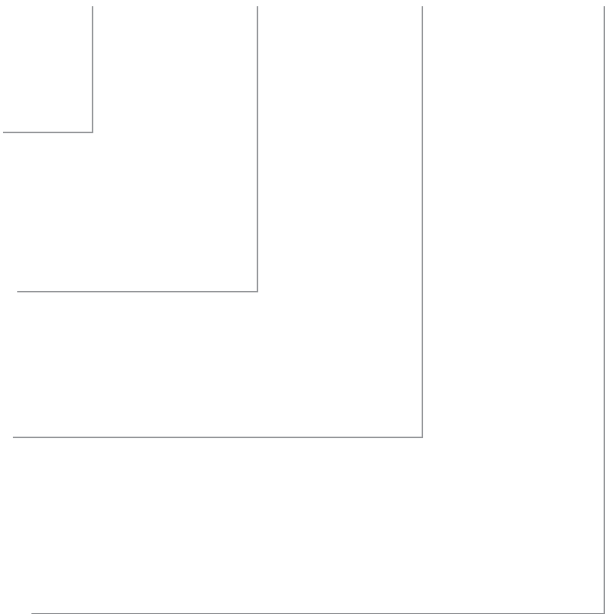

**Step 10: Attach the Thermostat onto its Mounting Plate until it clicks**

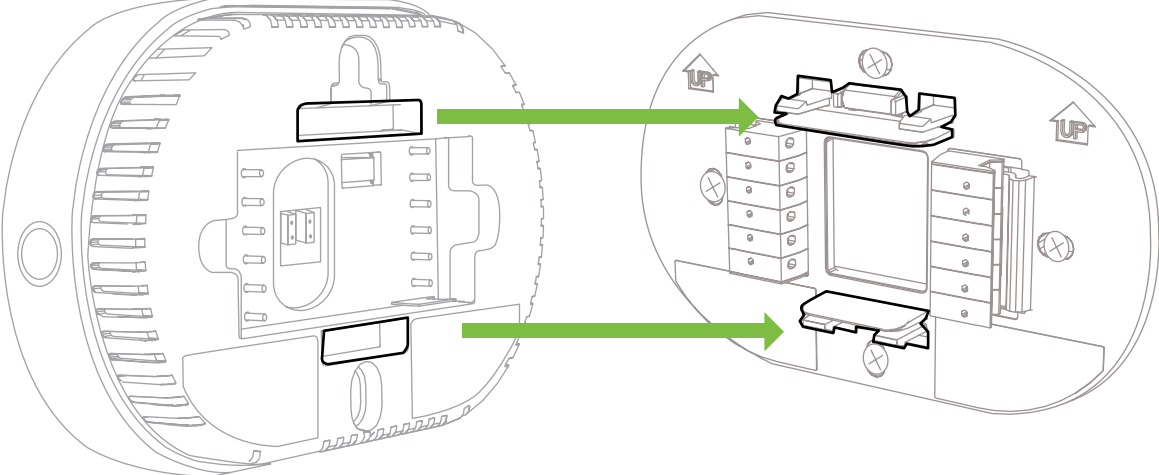



## Step 11: Turn on the power

Turn the power back ON for your HVAC system either at the Circuit Breaker Box or at the Main Switch.

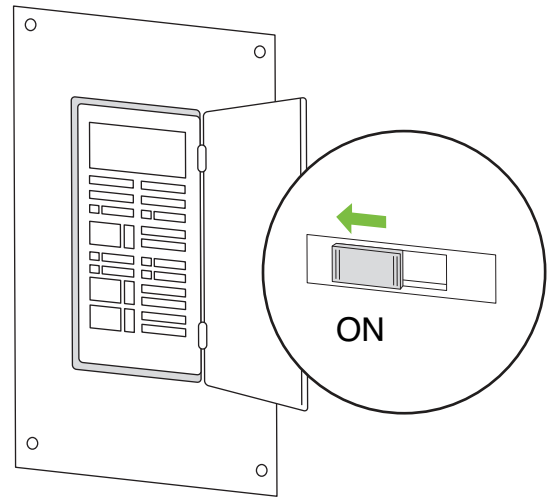
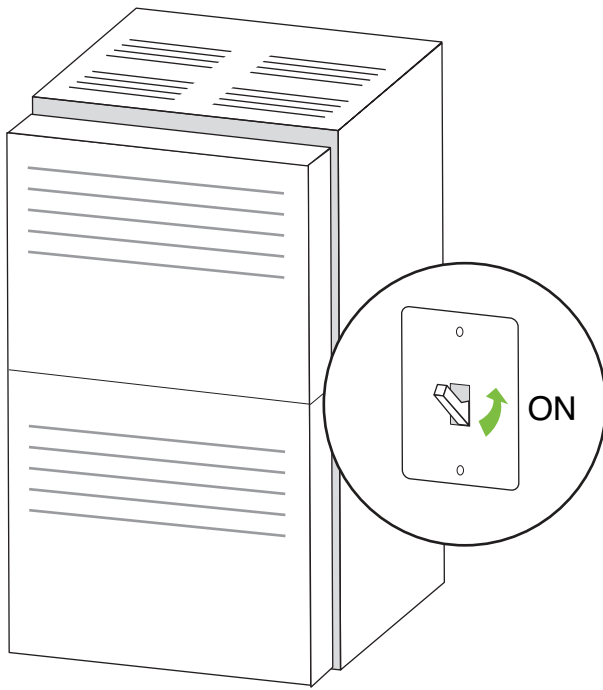

## Installation done!

Congratulations! You have completed your installation. Proceed to page [48](#) for details on how to configure and set up your Thermostat.

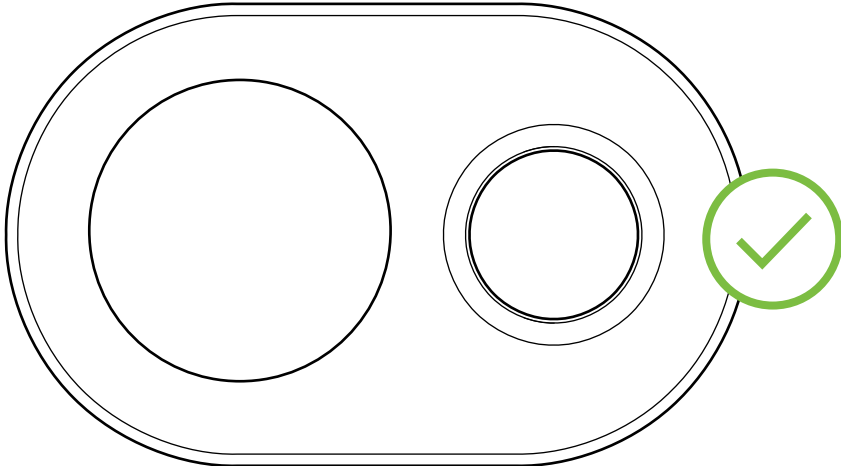

## Installation Without a C-Wire

If your system does not have a C-Wire, it will not power your new TrickleStar Thermostat. You need the TrickleStar C-Wire Adapter (sold separately as an accessory). For more information on the TS2104 C-Wire Adapter, visit our website at: [www.tricklestar.com](http://www.tricklestar.com)

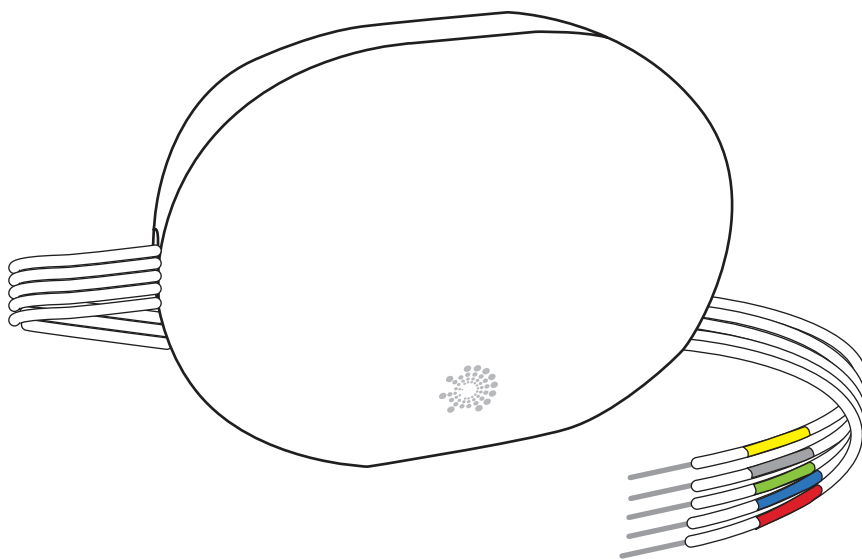

## Step 1: Check if there are 3 or 4 wires

The TrickleStar C-Wire Adapter requires your system to have either three or four wires:

**3 wires**  
**Y/Y1, G, and R (or Rc or RH)**

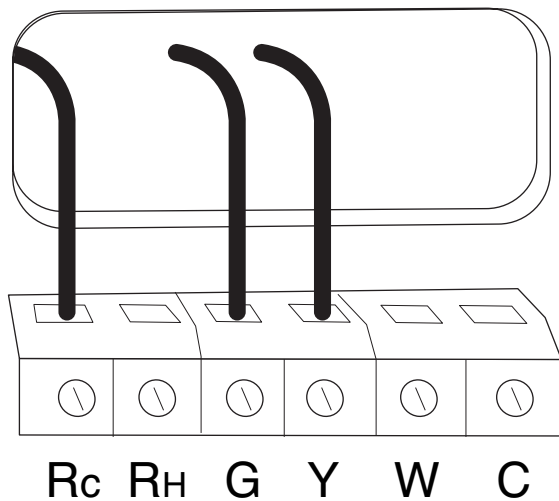

**3 wires**  
**W/W1/E, G, and R (or RC or RH)**

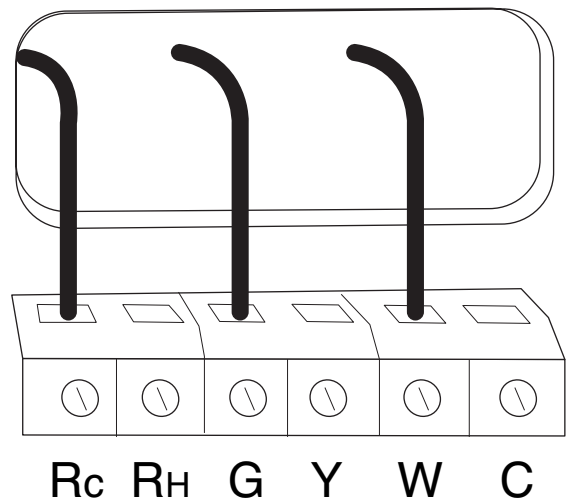

**4 wires**  
**W/W1/E, Y/Y1, G, and R (or Rc or RH)**

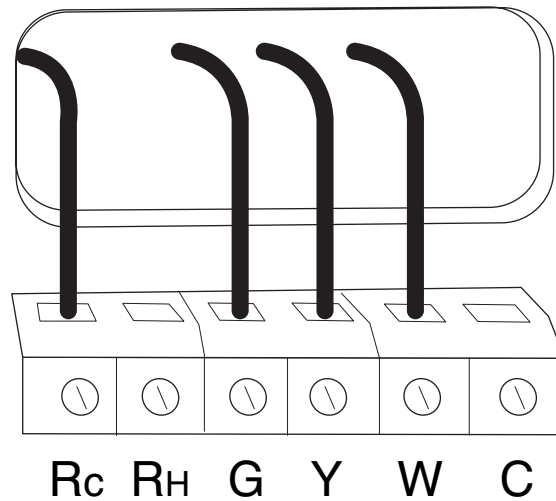

Yes

**Continue to the next page**

No

**Email or call our technical support:**  
Email: [customer.service@tricklestar.com](mailto:customer.service@tricklestar.com)  
Toll Free: 1-888-700-1098

## Step 2: Prepare the necessary tools

Bring along your TrickleStar C-Wire Adapter, wire labels, Phillips screwdriver and your mobile devices with Wi-Fi connection to your HVAC system.

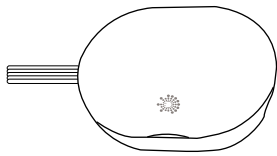

TrickleStar C-Wire Adapter

Label the wires at your control board.

R	R	G	G
Rc	Rc	Y/ Y1	Y/ Y1
RH	RH	W/ W1	W/ W1

Wire Labels

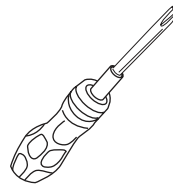

Phillips screwdriver

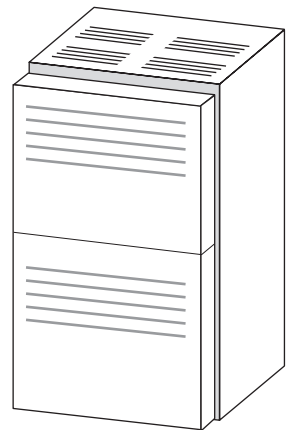

HVAC System

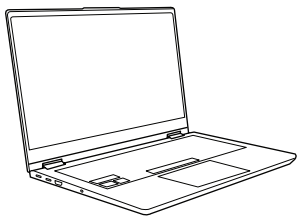

Laptop

or

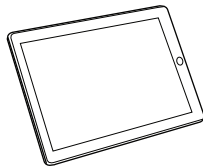

Tablet

or



Smartphone



**Note:**  
The HVAC system is usually located at the basement or the attic.

## Step 3: Open your HVAC system's cover

Open your HVAC system's cover to reveal the control board.

We recommend that you take a photo of the wires connected to the HVAC control board. You may need to refer to this photo at a later stage.

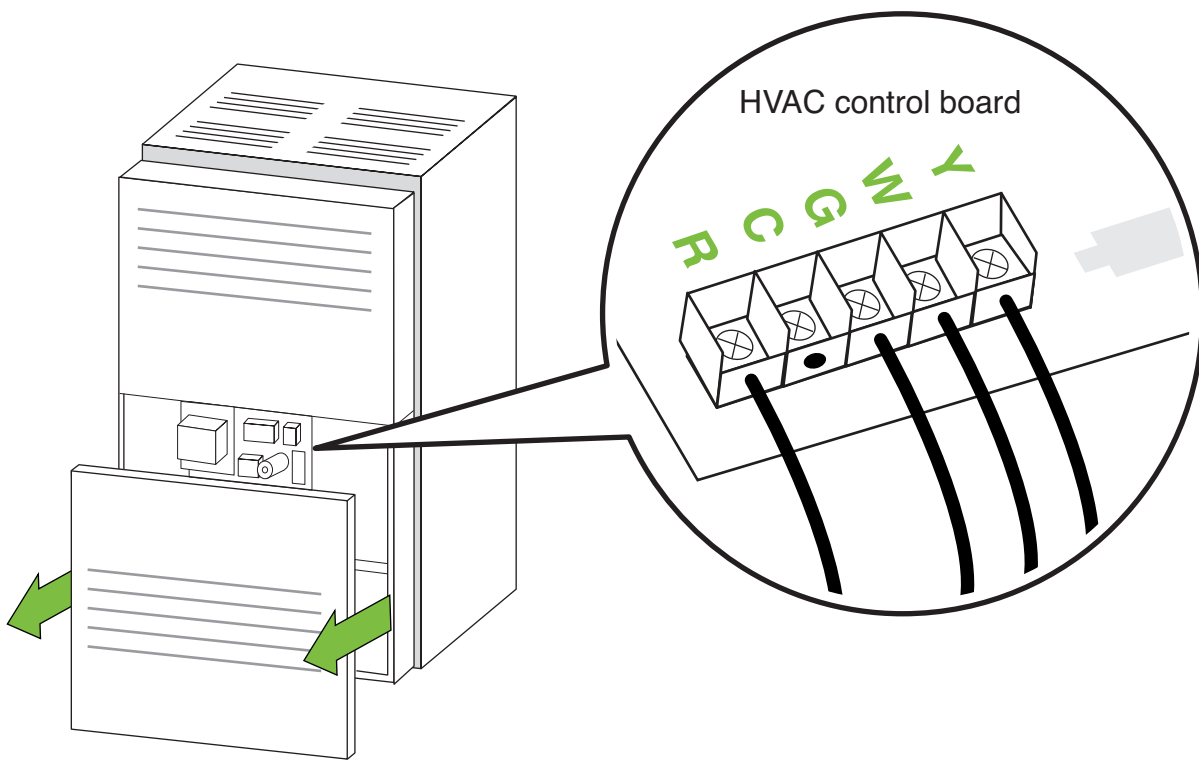

**Note:**

*The HVAC system contains high voltage circuitry and wires. Before you open your HVAC system's cover, be sure to check that you have turned off the power for your HVAC system.*

## Step 4: Label the wires

- Label only the R, Y/Y1, G, and W/W1 wires with the matching wire labels provided.
- If you have more than one wire going into these terminals, label only those wires going to your thermostat.

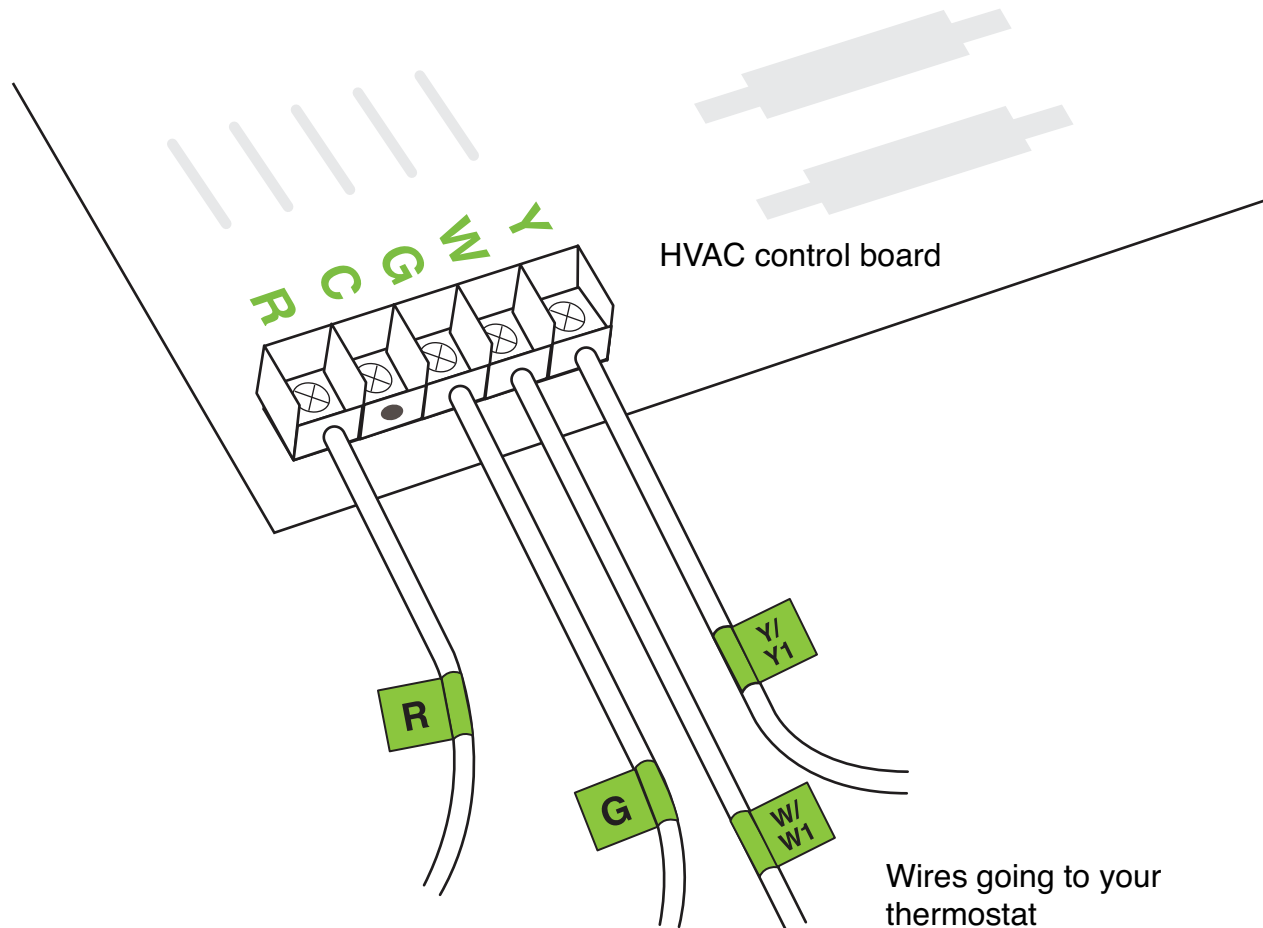

**Note:**

*If you have wires connected to both RC and RH terminals at the HVAC control board, you may have a two-transformer system. Contact our technical support to help you with the installation:*

*Email: [customer.service@tricklestar.com](mailto:customer.service@tricklestar.com)*

*Toll Free: 1-888-700-1098*



## Step 5: Disconnect the wires from the HVAC control board

Disconnect the wires labeled R, Y/Y1, G, and W/W1 from the HVAC control board.

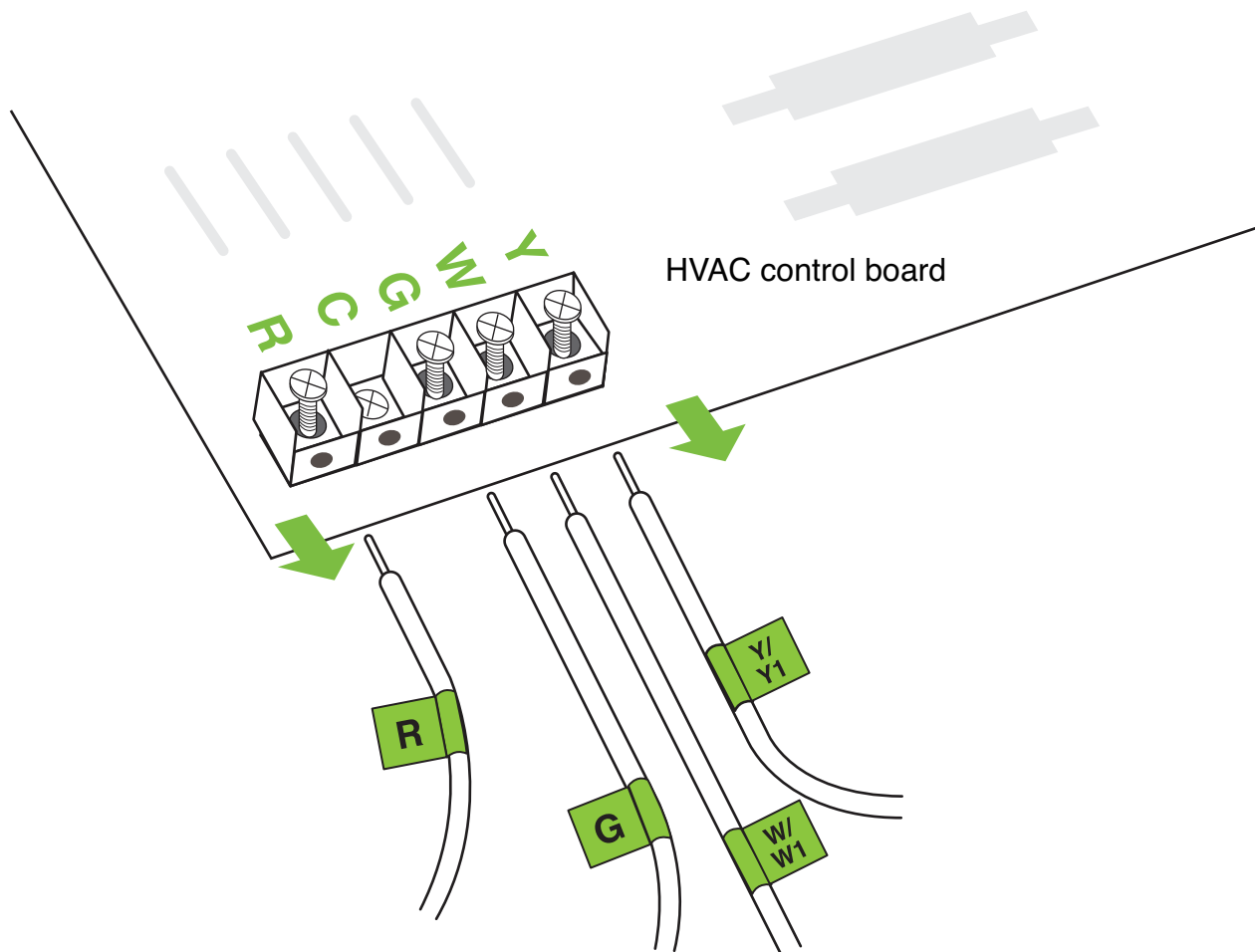

## Step 6: Connect the wires from the C-Wire Adapter to the HVAC control board

Connect the five white wires from your TrickleStar C-Wire Adapter to their corresponding terminals on the HVAC control board.

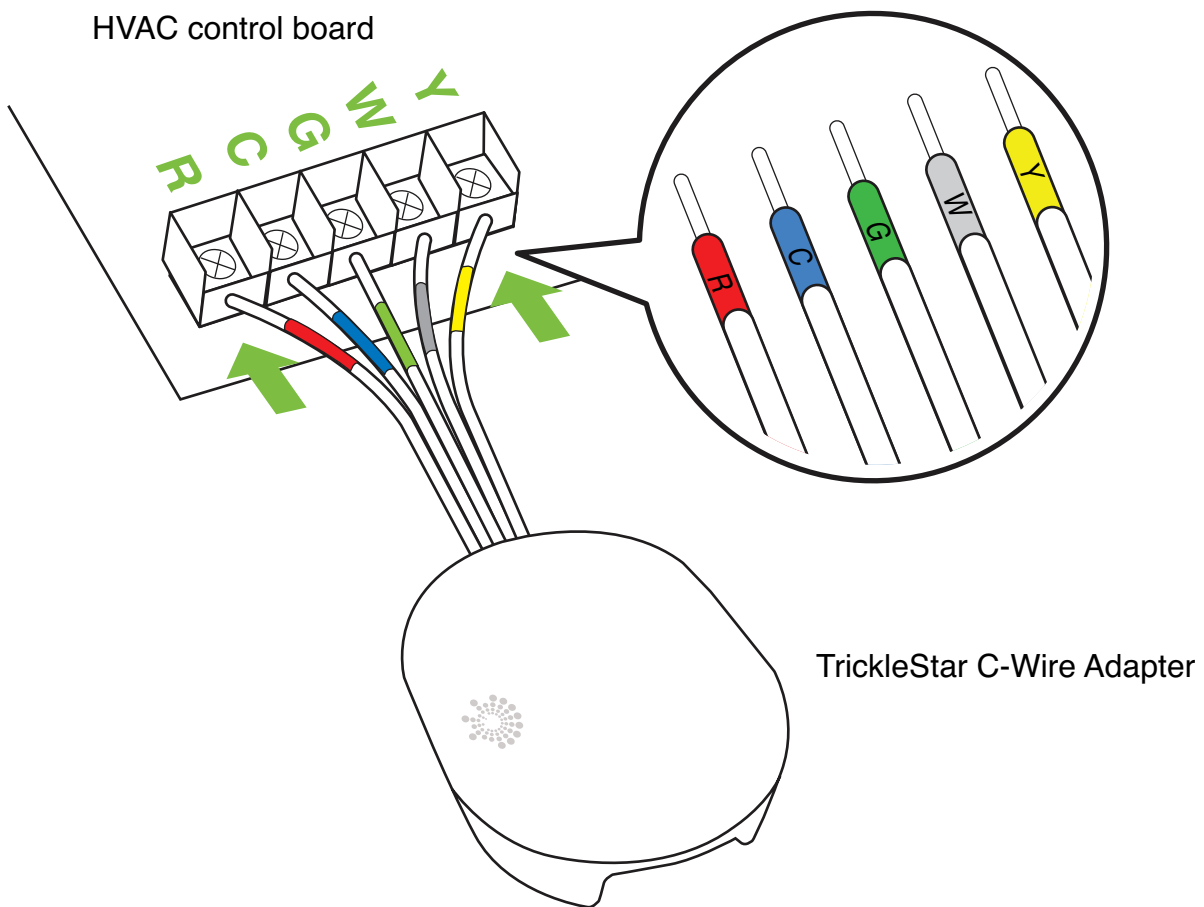

**Note:**  
*Pull the wires gently to ensure that they are connected securely.*

## Step 7: Connect the disconnected wires from the HVAC control board to the C-Wire Adapter

Connect the wires you disconnected from the HVAC control board in Step 5 to their corresponding terminals on the TrickleStar C-Wire Adapter.

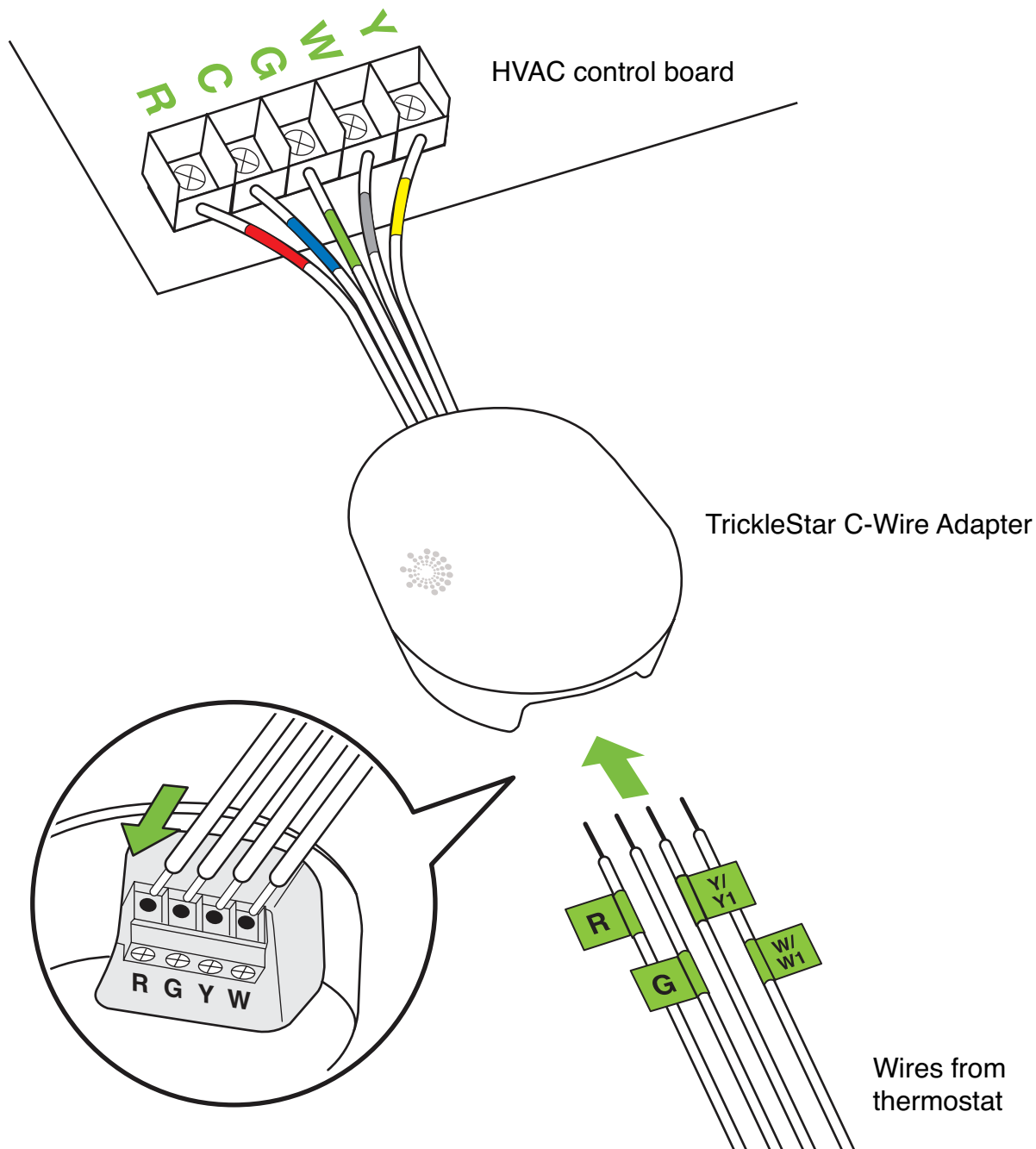

## Step 8: Mount the C-Wire Adapter inside your HVAC system

- Mount the TrickleStar C-Wire Adapter inside your HVAC system. Be sure not to strain the wires.
- Close your HVAC system's cover securely.
- You can now return to your thermostat.

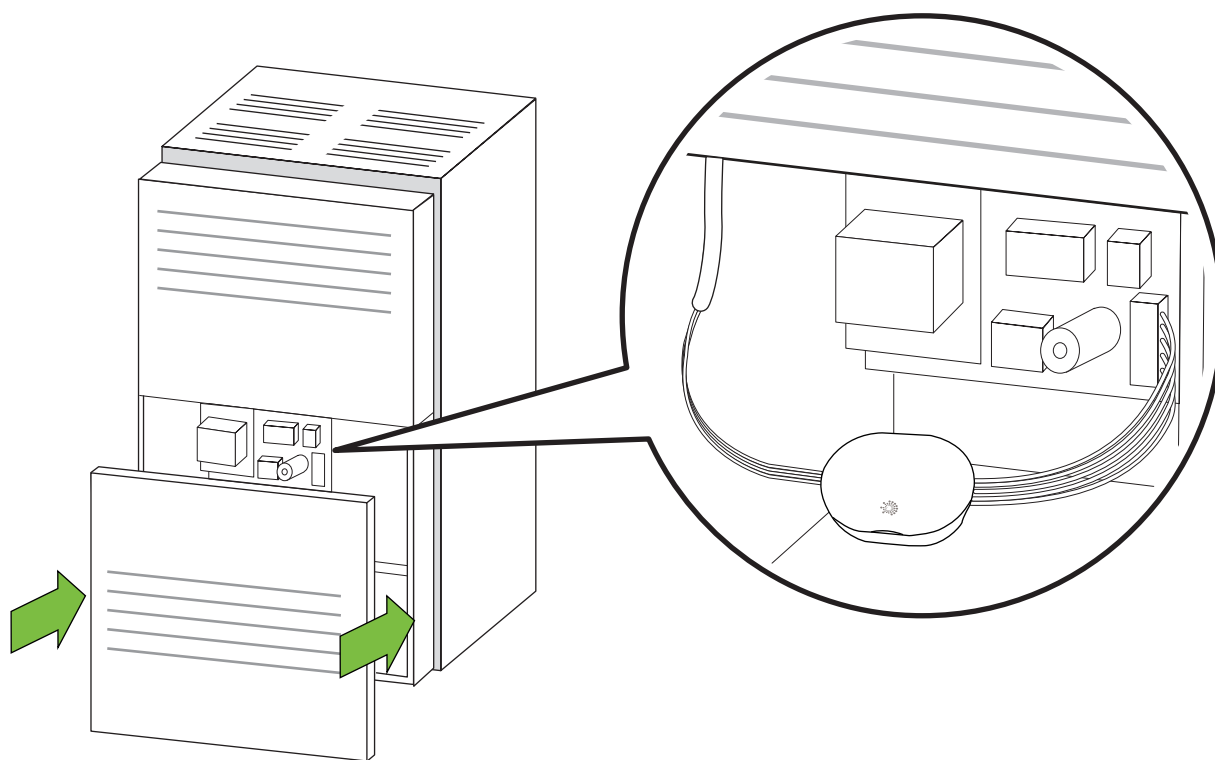

*Note: Make sure your HVAC system's cover is fully closed. Some HVAC systems will not turn on if the cover has not been closed properly.*

## Step 9: Disconnect and label old thermostat wires

Disconnect and label the wires from your old thermostat carefully, one wire at a time, using the wire labels provided. If you have connected the C-Wire Adapter, label the wire connected to the G terminal with the GK wire label and label the wire connected to the Y/Y1 terminal with the YK wire label.

Make sure the wires do not fall back into the wall when released from the terminals and that the labels are fastened to the wires securely.

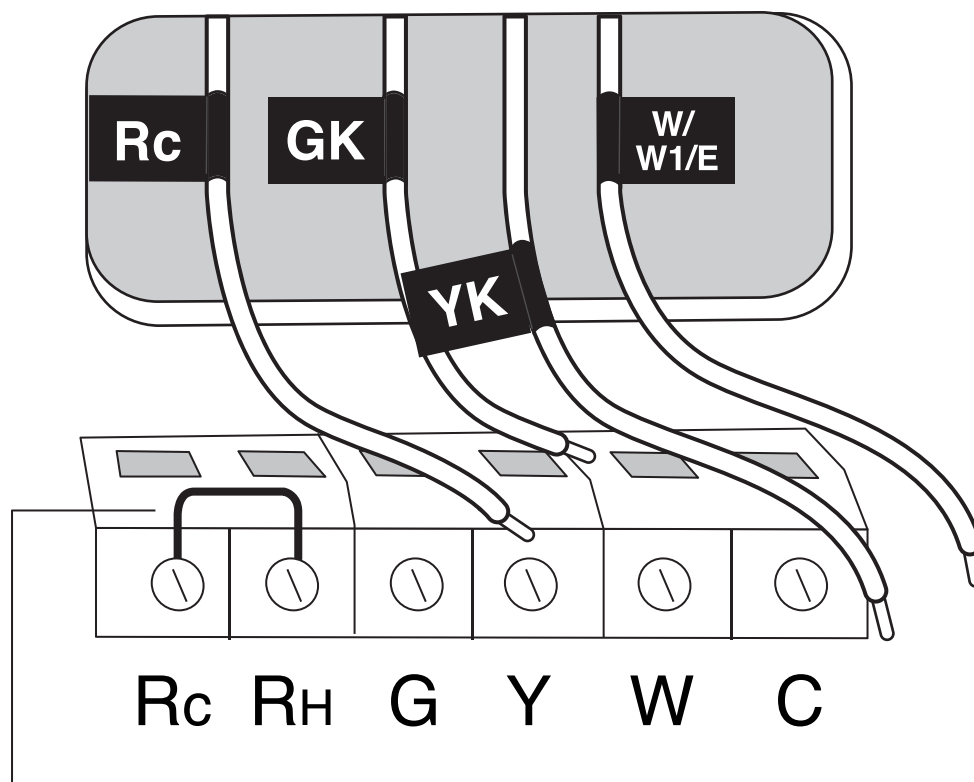

Jumper wire



*Note: If the terminals on your old thermostat has a jumper wire between RH, RC or R, remove the jumper wire. Your new TrickleStar Thermostat does not need this jumper wire.*

## Step 10: Unscrew old Mounting Plate

Unscrew the Mounting Plate of your old thermostat to remove it from the wall. When you remove the Mounting Plate, be sure not to tear off the labels on the wires.

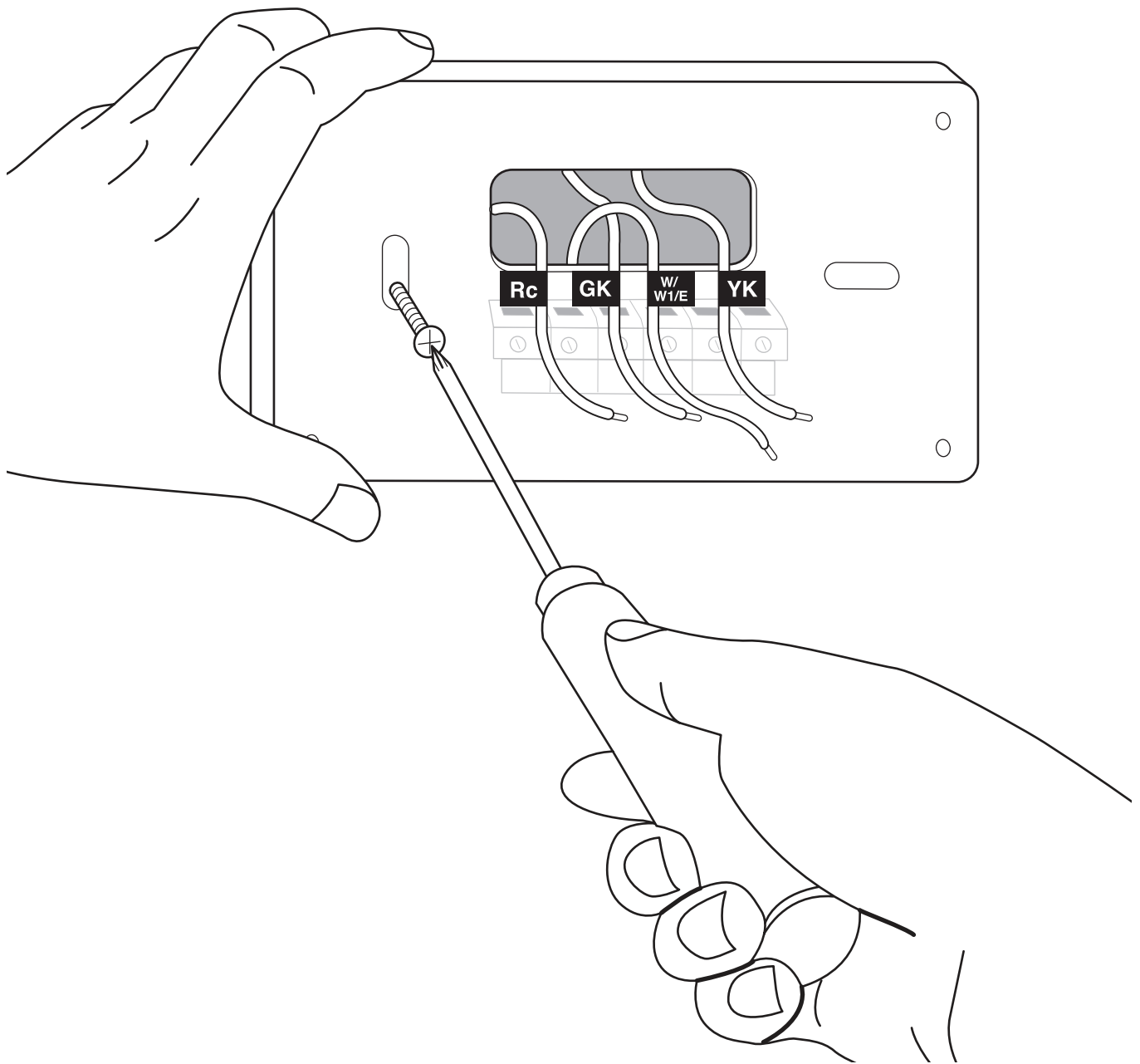

## Step 11: Replace with new Thermostat Mounting Plate

Decide if you want to mount the TrickleStar Thermostat directly to the wall via the Mounting Plate or you want to use the Trim Plate. The Trim Plate helps you to hide marks or holes left on the wall by your old thermostat.

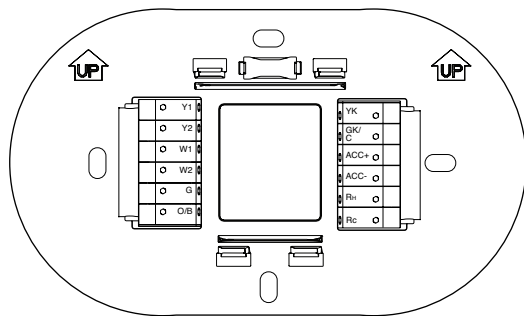

Mounting Plate

OR

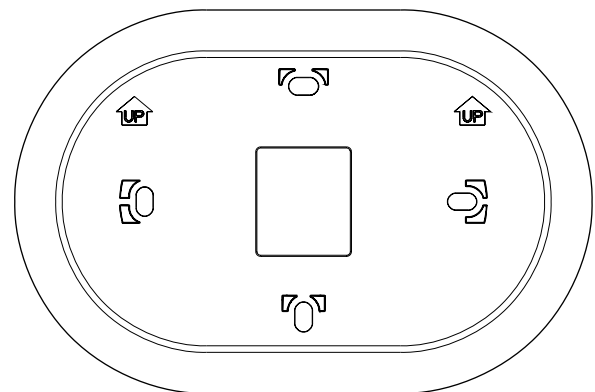

Trim Plate

## Step 12: If the Trim Plate is used (Optional)

If you use the Trim Plate, align the mounting holes on the Trim Plate and Mounting Plate, then press them together into place.

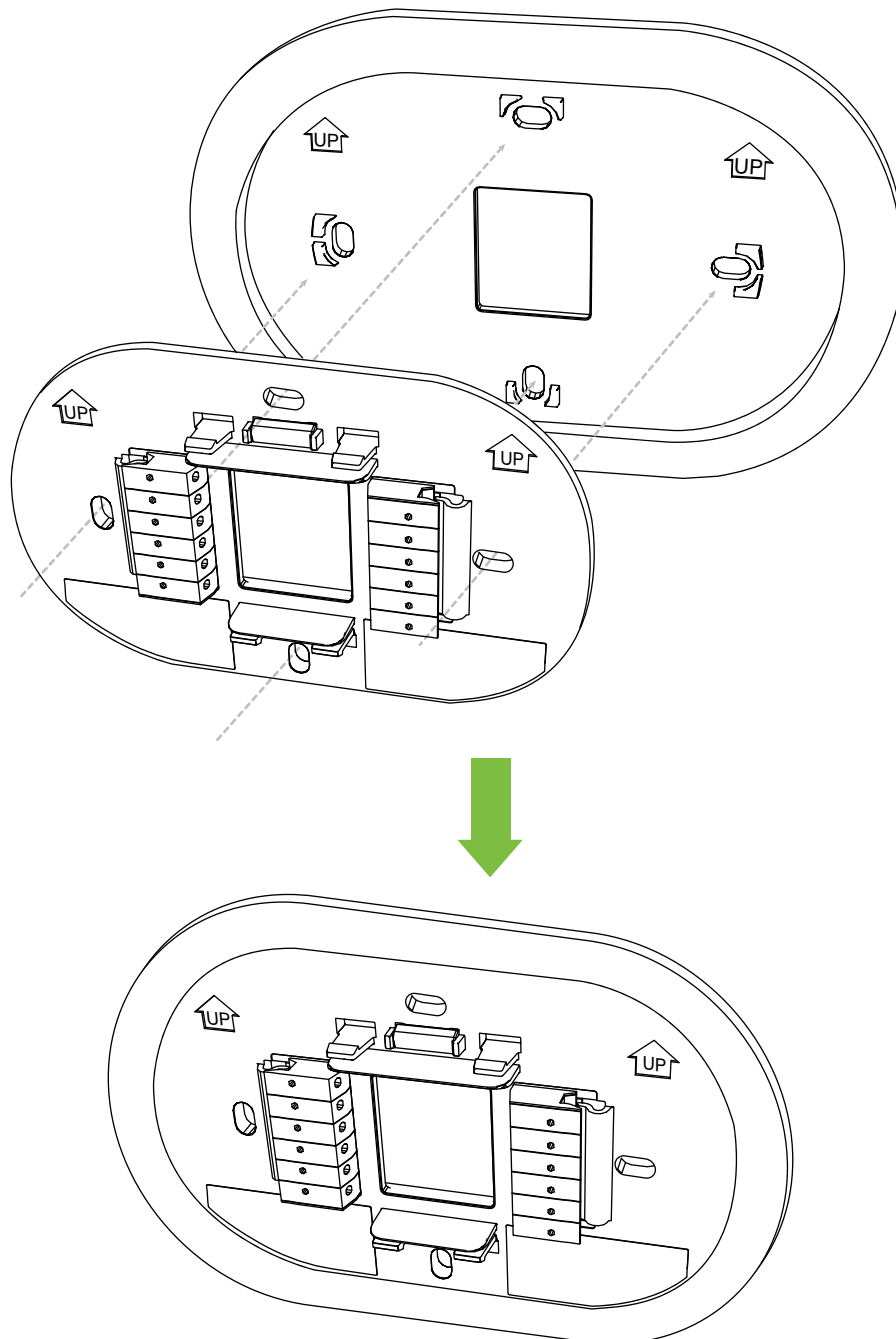



## Step 13: Pull the labeled wires through the hole of the Mounting Plate

Pull the labeled wires carefully through the hole of the Mounting Plate.

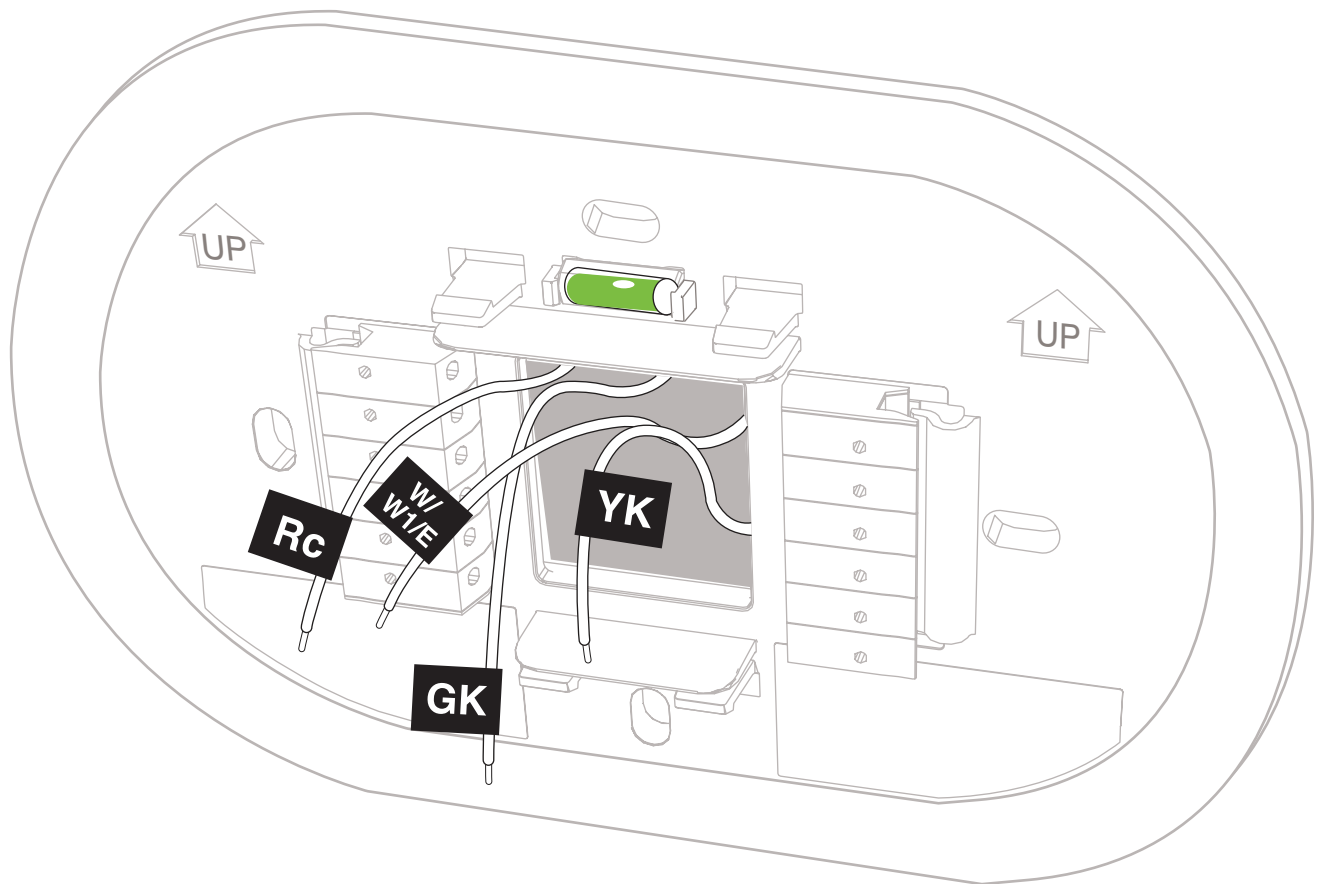

## Step 14: Attach the Mounting Plate on the wall

Attach the Mounting Plate on the wall using the drywall plugs and screws provided. Use the built-in bubble level to make sure the base is level.

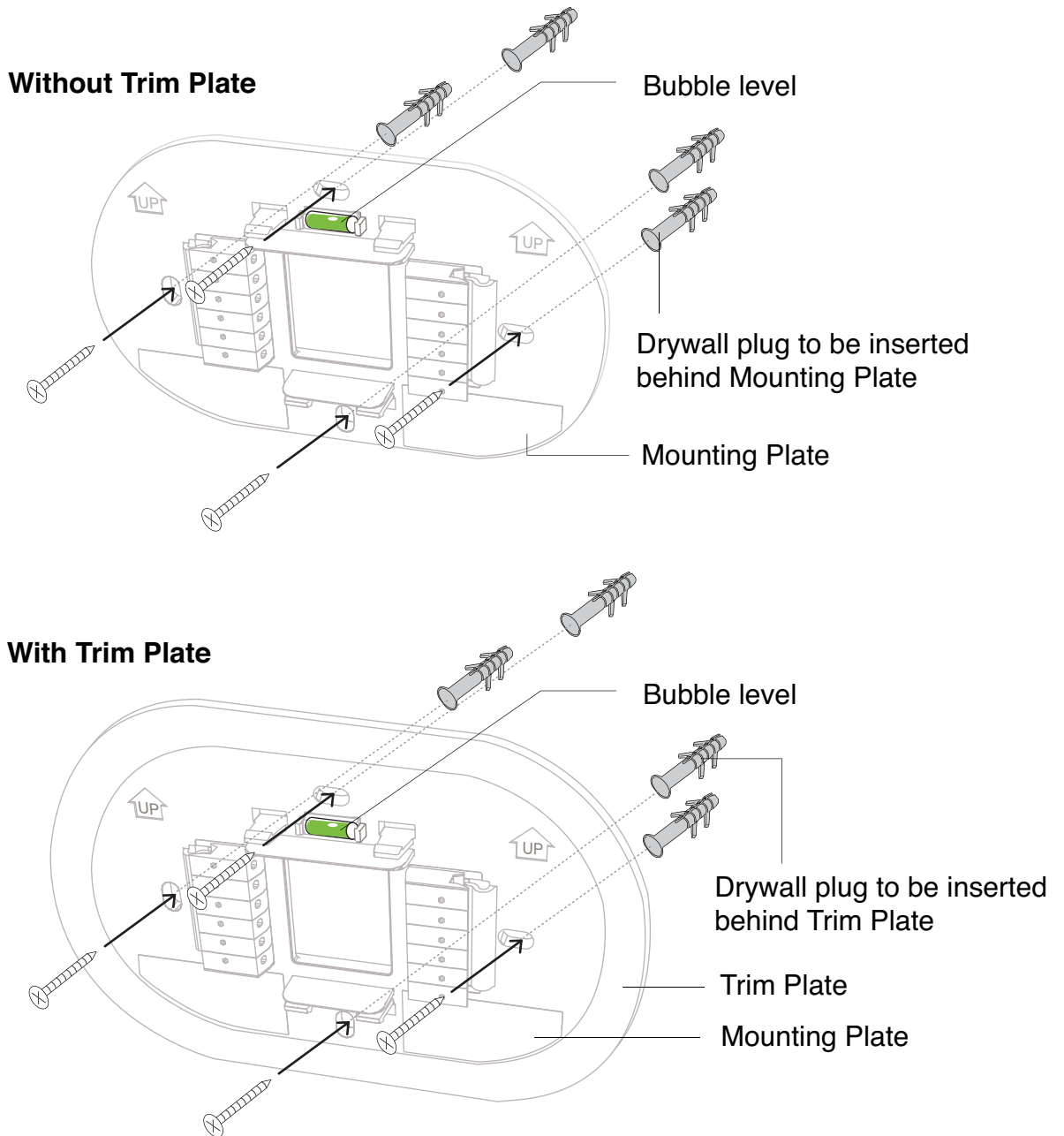

## Step 15: Connect the wires

- Connect the RC, GK, YK and W/W1/E wires to their corresponding terminals on the Thermostat Mounting Plate as shown below.
- Connect any remaining wires to their corresponding terminals on the Thermostat Mounting Plate.

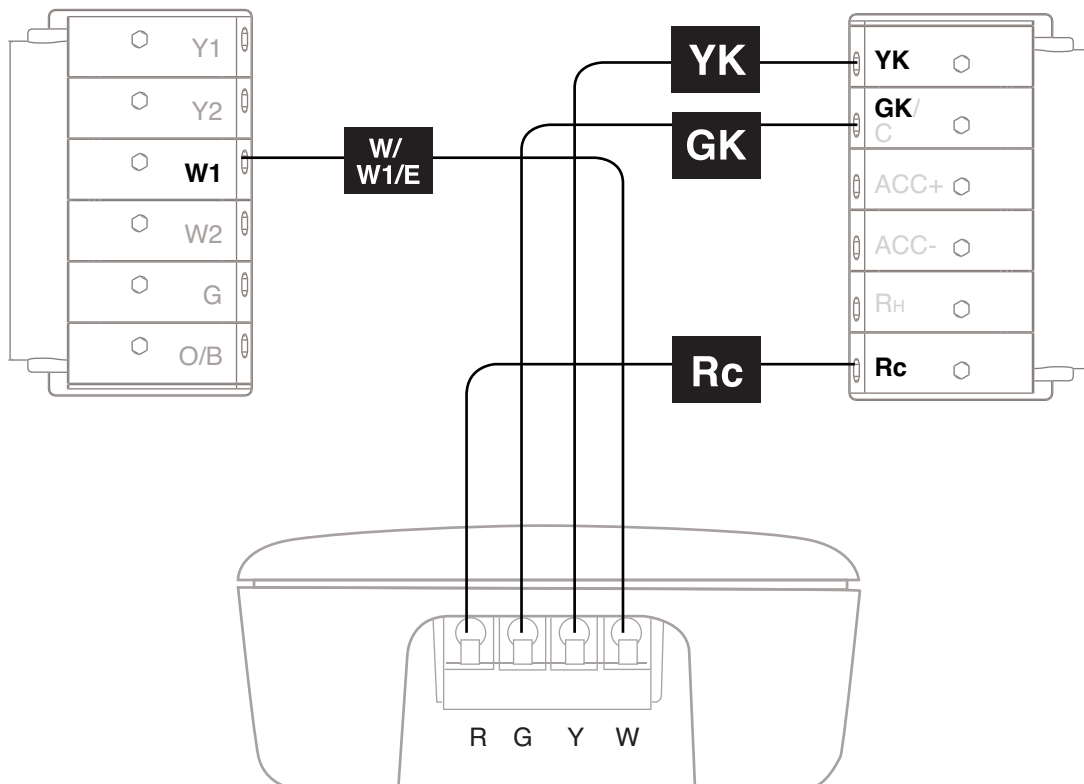

### Note:

- You can refer to “Wiring Diagrams” from pages [54](#) to [59](#) for some common HVAC equipments.
- Connect any remaining wires to their corresponding terminals. Pull the wires gently to ensure that they are connected securely.
- Tape the ends of any excess wires and push the wires back into the wall carefully.
- Make sure there is no draft coming from the hole in the wall as it may affect the temperature readings.

## Step 16: Set the jumpers on the back of your Thermostat

Accessory wires on the thermostat (ACC+ and ACC-) are used to power devices such as a humidifier or a dehumidifier. If your HVAC system does not have any accessory wires, you can leave the black jumper in either position.

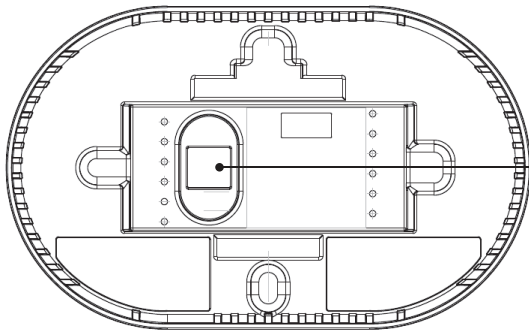

**⚠ Jumper Position for Accessory & RH Wire**

<b>2 ACC wires with RH Wire (Default position)</b>	<b>2 ACC wires without RH wire</b>	<b>1 ACC wire with RH wire</b>	<b>1 ACC wire without RH wire</b>

ACC wire  
 RH wire

**Note :** If there is no ACC wire, the black jumper can be in either position.

If your Accessory item has two wires, and your HVAC system has an RH wire, set jumpers as illustrated. This is the default position.

If your Accessory item has two wires, and your HVAC system does not have an RH wire, set jumpers as illustrated.

If your Accessory item has one wire, and your HVAC system has an RH wire, set jumpers as illustrated.

If your Accessory item has one wire, and your HVAC system does not have an RH wire, set jumpers as illustrated.

**Step 17: Attach the Thermostat onto its Mounting Plate until it clicks**

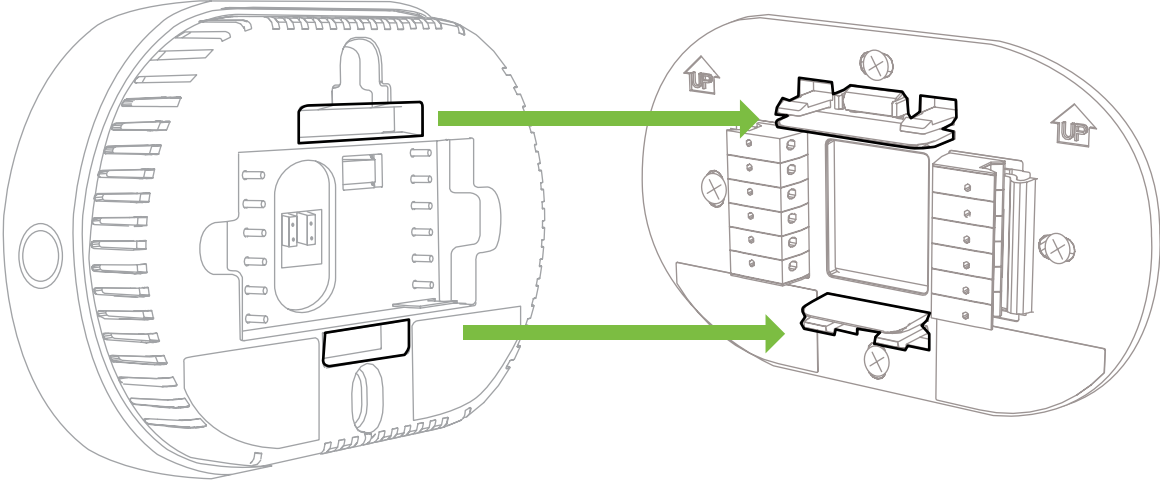

## Step 18: Turn on the power

Turn the power back ON for your HVAC system either at the Circuit Breaker Box or at the Main Switch.

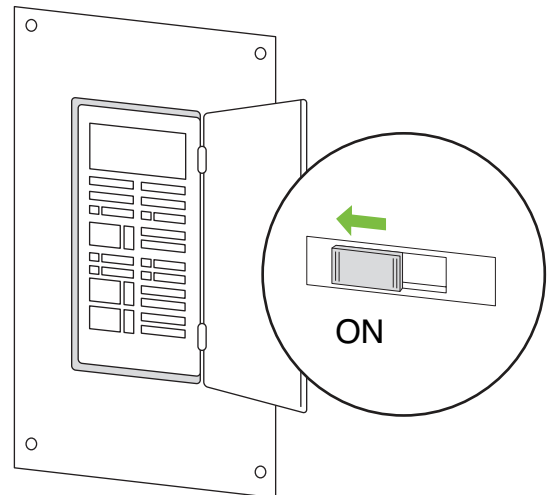
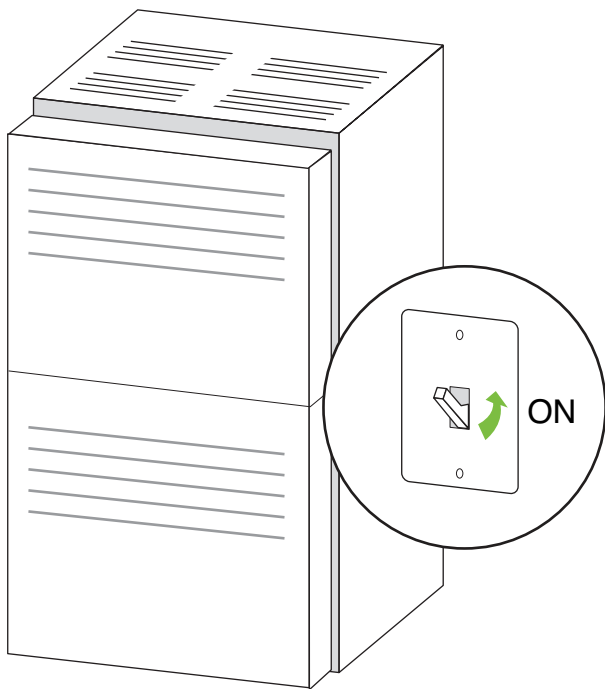

## Installation done!

Congratulations! You have completed your installation. Proceed to page [48](#) for details on how to configure and set up your Thermostat.

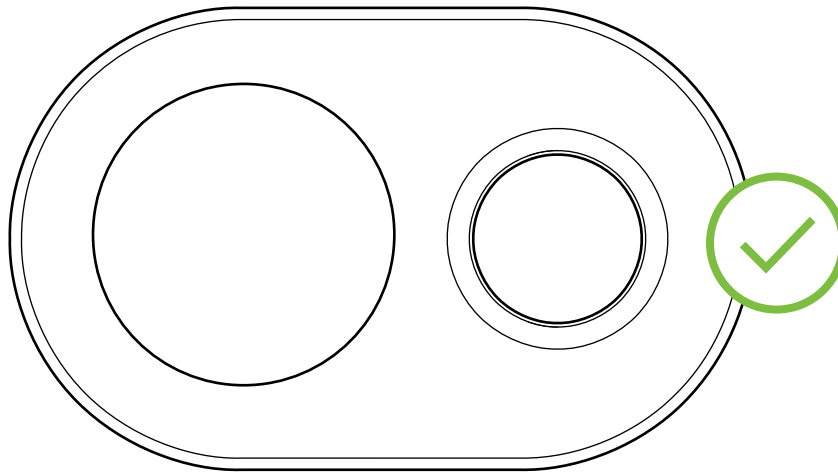

## Online Start-Up Configuration using Wi-Fi Connection

If you have a Wi-Fi connection, we recommend that you connect your TrickleStar Thermostat to Wi-Fi via the TrickleStar Portal to enjoy the full set of features. You can also monitor and control your HVAC system from anywhere.

Refer to the Quick Start Guide, or access Portal at [portal.tricklestar.com](http://portal.tricklestar.com), to create your Portal account. The TrickleStar Portal is also mobile browser friendly, so you may visit the Portal using the browser in your smartphone.

### Start-Up Configuration Mode

Upon first time power up, you should see this display on the Thermostat. Login to your Portal account, select “Devices” tab on the left menu panel, click “Add New +”, and select “Wi-Fi Smart Thermostat” to see the Thermostat Setup Wizard. Follow the instructions to complete the online Start-Up Configuration.

#### Tips:

If you have completed the Thermostat installations, you may proceed to “Step 2: Connect TrickleStar thermostat to Wi-Fi” in the Thermostat Setup Wizard.



### Ready to use

When you have completed the Start-Up Configuration via the TrickleStar Portal, the Thermostat will enter Normal Operation and you will see this display on the Thermostat. Your Thermostat is now ready to use.





## Offline Start-Up Configuration without using Wi-Fi Connection

Alternatively, if you do not have Wi-Fi connection, your TrickleStar Thermostat can only support a limited range of features and will work as a simple non-programmable Thermostat.

## Start-Up Configuration on the Thermostat

When you turn on power to your TrickleStar Thermostat for the very first time, the steps on the LCD display will guide you through the Offline Start-Up Configuration.

### Step 01 - Wi-Fi provisioning

Press the jog dial to skip this step.



## Step 02 - Select your HVAC system

1. Rotate the jog dial to select:
  - “HC” for conventional system.
  - “HP” for heat pump system.
2. Press the jog dial to confirm your selection.



## Step 03 – Select fan control option

1. Rotate the jog dial to select:
  - “HG” for gas heating.
  - “HE” for electric heating.
2. Press the jog dial to confirm your selection.



## Step 04 – Select heat pump reversing valve option

If you have selected “HP” for heat pump system in Step 02, this option will be displayed.

1. Rotate the jog dial to select:
  - “o” for a system in which the reversing valve is energized in cooling.
  - “b” for a system in which the reversing valve is energized in heating.
2. Press the jog dial to confirm your selection.



## Step 05 – Test the connection of each output

This step helps you to check if the output terminals were connected correctly and securely. During the connection test, check if your HVAC equipment connected to the respective output terminal is turned on.

1. Rotate the jog dial clockwise to turn on the output as follows:

- **--** : All outputs off
- **Y1** : Only Y1 is on, all others off
- **Y2** : Only Y2 is on, all others off
- **W1** : Only W1 is on, all others off
- **W2** : Only W2 is on, all others off
- **G** : Only G is on, all others off
- **ob** : Only O/B is on, all others off
- **ACC** : Only ACC is on, all others off

After you rotate the jog dial, there may be a few seconds delay before the HVAC equipment turns on. This is not a malfunction.

2. Press the jog dial to end the connection test.  
All the outputs will be turned off.





**Note:**

- To stop and exit the Start-Up Configuration, press and hold the Side button for approximately 5 seconds. The Thermostat will apply default settings as follows:
  - HVAC type: HC (conventional system)
  - Fan control option: HG (gas heating)
  - Output test
- The output terminals are tested in a predefined sequence to ensure the safety of your HVAC equipment. As such, after you have tested a specific output and proceeded to the next, you are not allowed to test the previous output again. If you need to retest the previous output, reenter the Start-Up Configuration as follows: Press and hold the Side button for approximately 10 seconds. It will restart from Step 01.

## Ready to use

When you have completed the Start-Up Configuration on the Thermostat, the Thermostat will enter Normal Operation and you will see this display on the Thermostat. Your Thermostat is now ready to use.



*Note: If there is no input for more than one minute in Step 02 to Step 05, the Thermostat will exit the Start-Up Configuration and return to Normal Operation.*

## Wiring Diagrams

### Conventional heating and cooling systems

Wire the conventional heating and cooling systems up to 2 stages each as shown below.

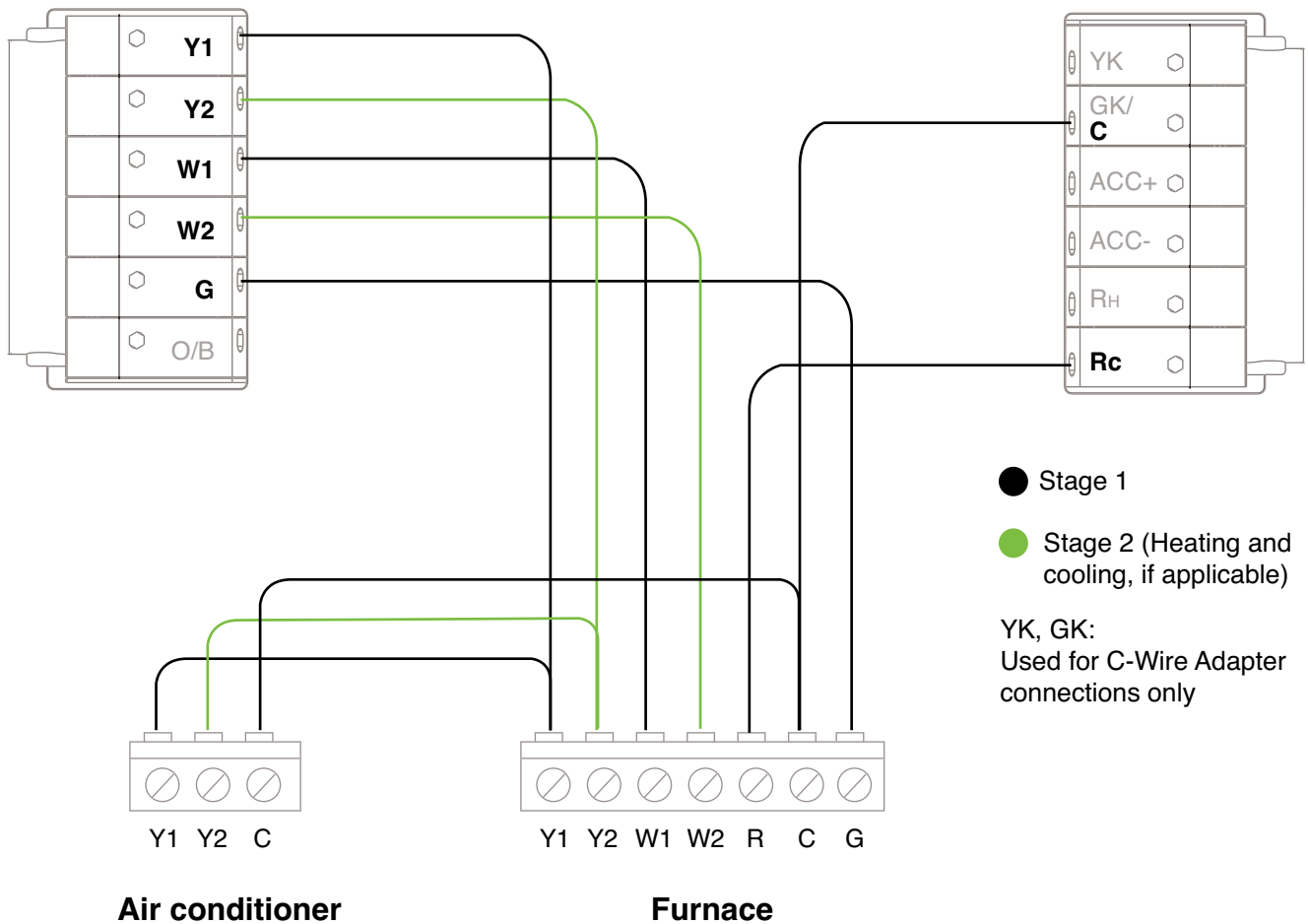

**Note:**

- Connect the R wire to the RC terminal on your TrickleStar Thermostat.
- Do not connect any jumper wire between RC and RH terminals.
- Refer pages [23](#) or [44](#) for details on setting the jumpers on the Thermostat.

## Heat pump with auxiliary heat

Wire the heat pump (air or geothermal) with auxiliary heat as shown below.

In this setup, the HVAC system supports 4 Heating and 2 Cooling stages:

- Y1 or Y2 - Heat Pump Compressor stages 1 or 2 (Heating and Cooling)
- W1 or W2 - Auxiliary stages 1 or 2 (Heating only)
- O/B - whether Y1 and Y2 is in Heating or Cooling mode

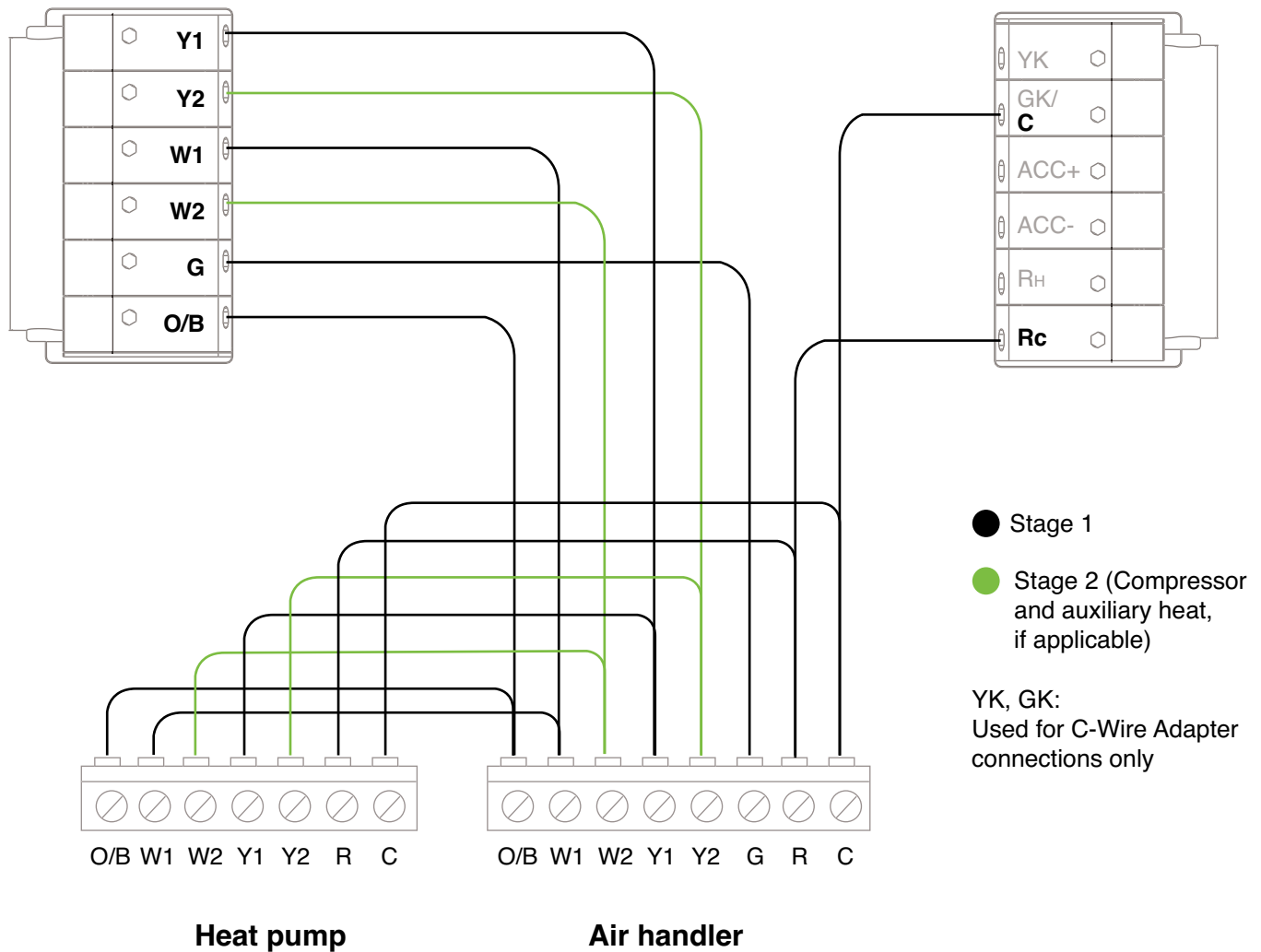

**Note:**

- Connect the R wire to the RC terminal on your TrickleStar Thermostat.
- Do not connect any jumper wire between RC and RH terminals.
- Refer pages [23](#) or [44](#) for details on setting the jumpers on the Thermostat.

## Boiler and radiant system

Wire the boiler or radiant system with air handler and conventional cooling and heating system as shown below.

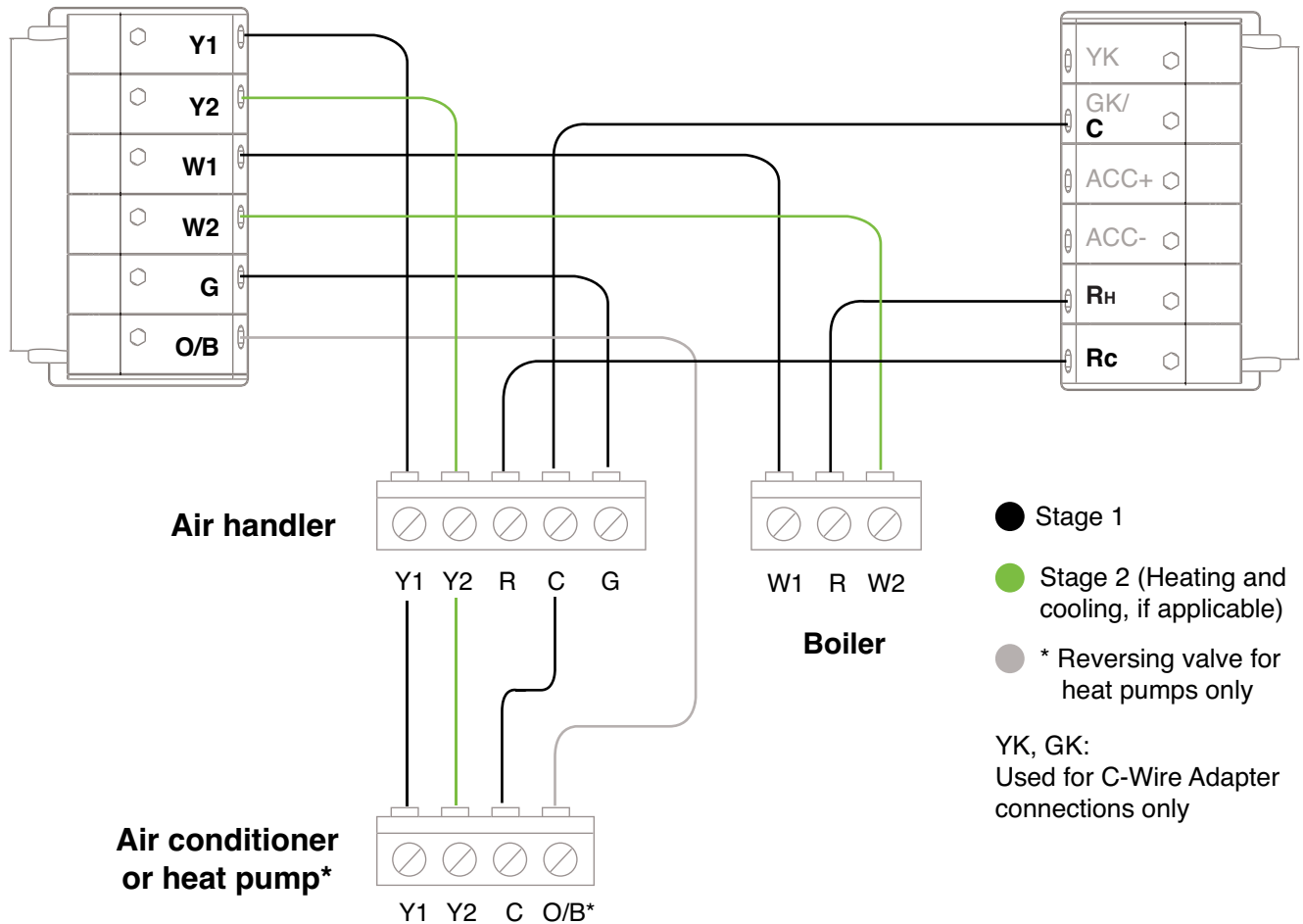

**Note:**

- Connect the R wire to the RC terminal and the other R wire from your boiler to the RH terminal on your TrickleStar Thermostat.
- Do not connect any jumper wire between RC and RH terminals.
- Refer pages [23](#) or [44](#) for details on setting the jumpers on the Thermostat.



## C-Wire Adapter wiring

Wire the TrickleStar C-Wire Adapter as shown below.

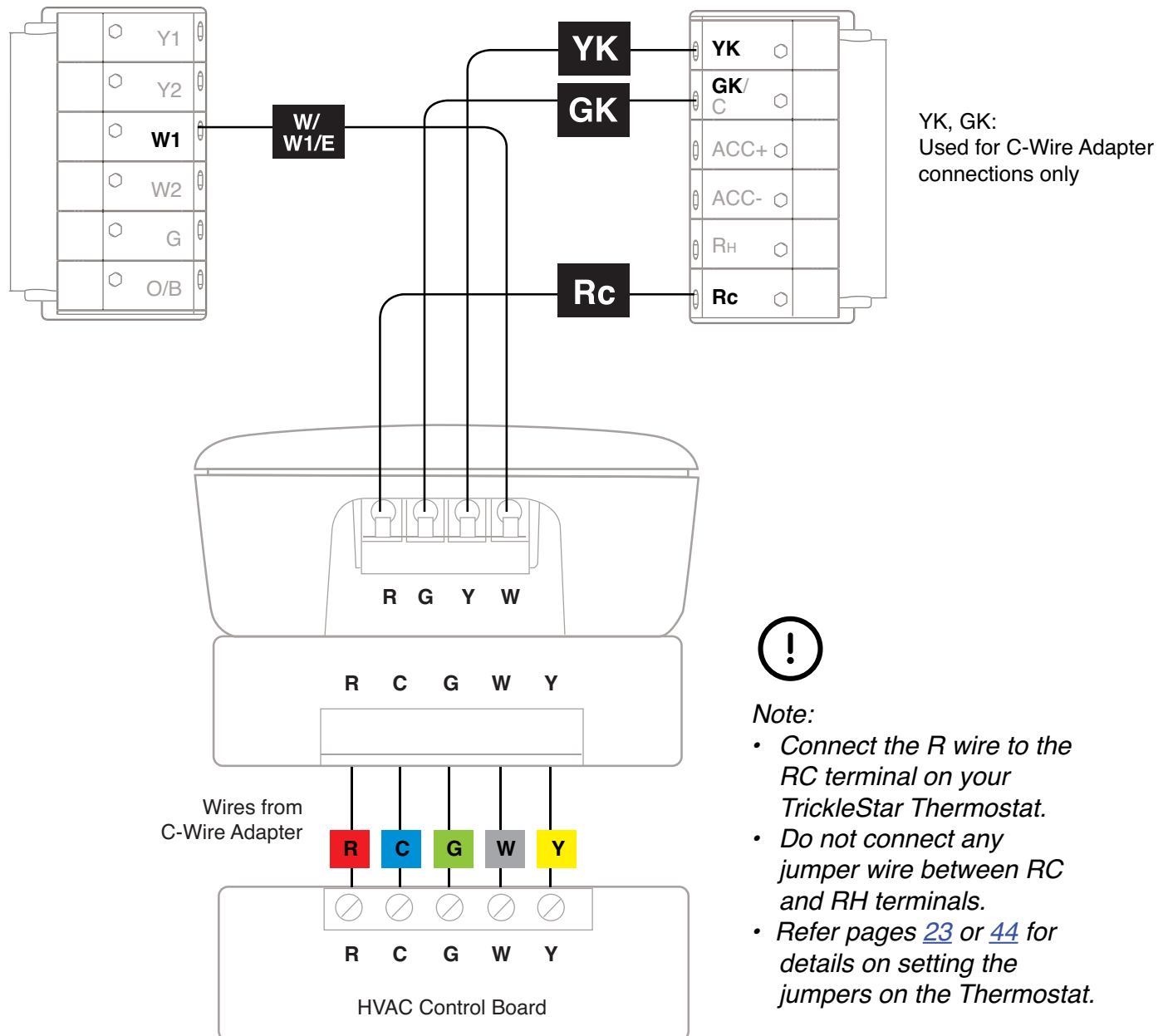

## C-Wire Adapter wiring (for conventional heat only HVAC systems with 3 wires)

For conventional heat only HVAC systems with 3 wires, wire the TrickleStar C-Wire Adapter as shown below.

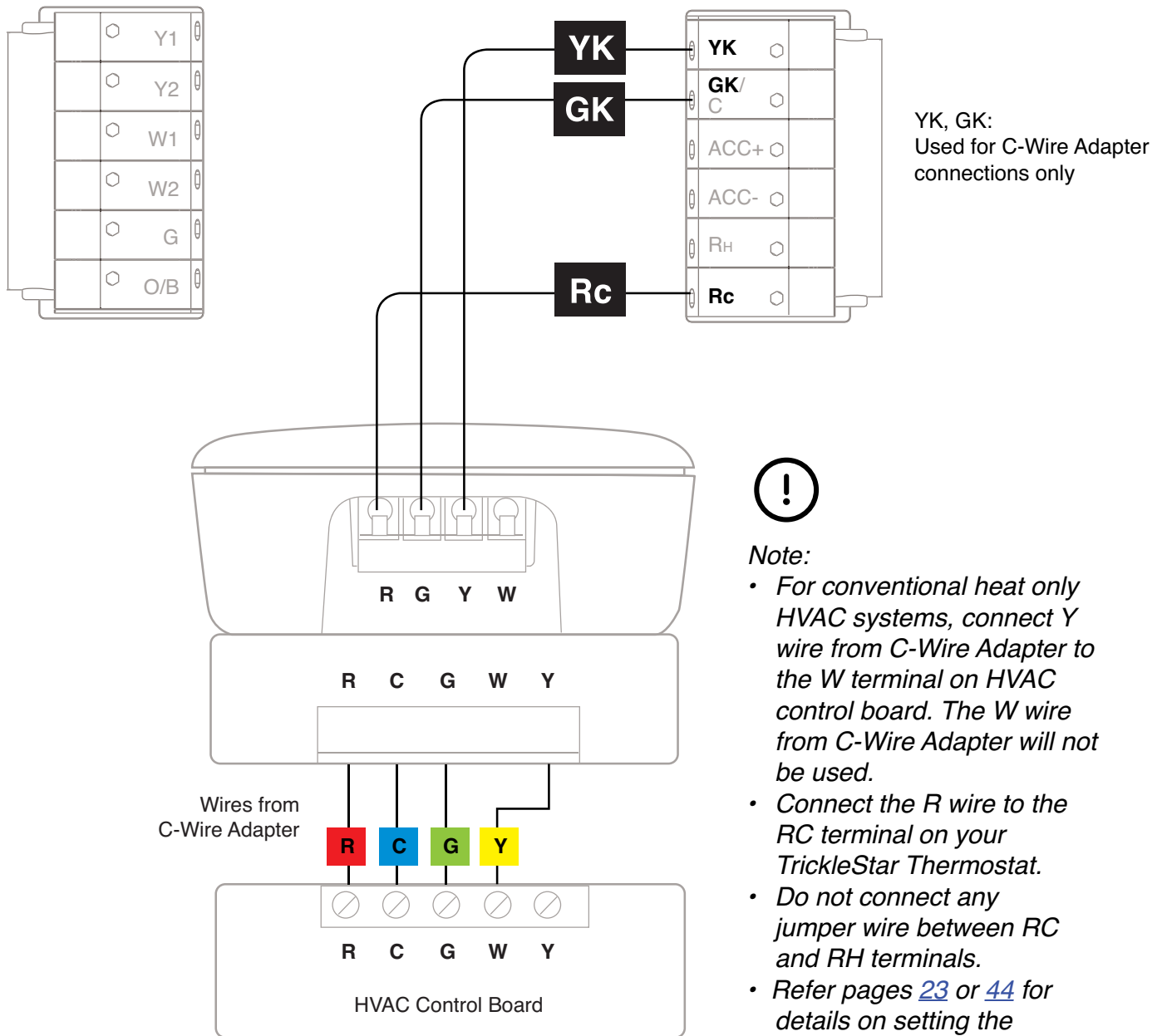

## Accessory with one wire (humidifier/dehumidifier)

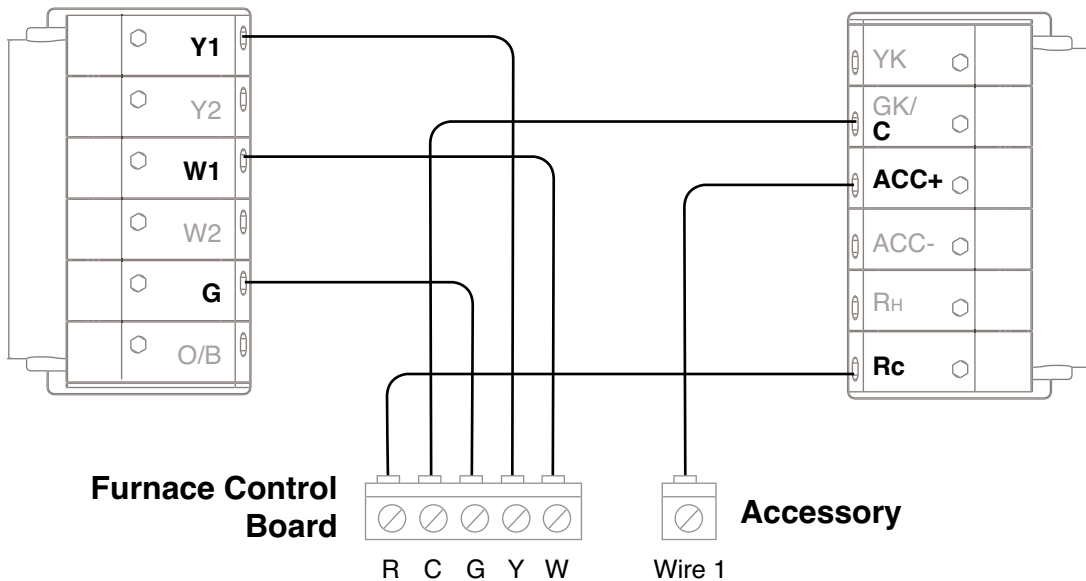

YK, GK:  
Used for C-Wire Adapter  
connections only

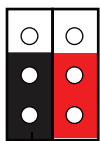

Black jumper

Place the black jumper at the back of your Thermostat as illustrated.



**Note:**

- If your Accessory item has only one wire, connect it to the ACC+ terminal on the Thermostat to control the Accessory.
- Do not connect any jumper wire between RC and RH terminals.
- Refer pages [23](#) or [44](#) for details on setting the jumpers on the Thermostat.



**Warning!** If you connect the accessory wire to the ACC- terminal, it may damage your Thermostat or HVAC system.

## Accessory with two wires (humidifier/dehumidifier)

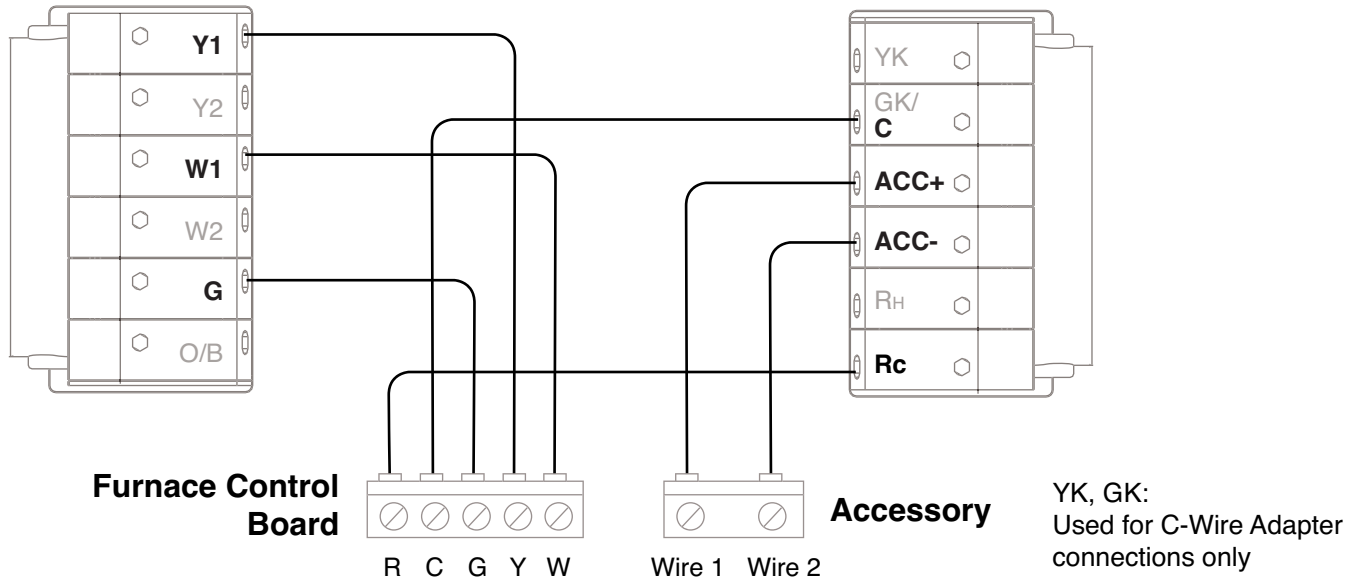

Black jumper

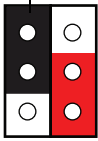

Place the black jumper at the back of your Thermostat as illustrated.



**Note:**

- If your Accessory item has two wires, connect them to the ACC+ and ACC- terminals on the Thermostat to control the Accessory.
- Do not connect any jumper wire between RC and RH terminals.
- Refer pages [23](#) or [44](#) for details on setting the jumpers on the Thermostat.

## Troubleshooting

Symptom	Solution
<p>Your Thermostat does not turn on after installation.</p>	<ul style="list-style-type: none"> <li>• Check that all wires are connected correctly to the terminals on the Thermostat. Pull the wires gently to ensure that they are connected securely.</li> <li>• Make sure your HVAC system's cover is fully closed. Some HVAC systems will not turn on if the cover has not been closed properly.</li> <li>• If you installed a C-Wire Adapter, make sure that all the wires are connected correctly. Pull the wires gently to ensure that they are connected securely.</li> <li>• If there is only one R wire (R, RC, or RH), make sure that it is connected to the RC terminal on the Thermostat.</li> </ul>
<p>Your Thermostat cannot be registered via the TrickleStar Portal.</p>	<p>If the TrickleStar Portal request for the DSN number, refer to your photo of the label at the bottom of the Thermostat (<a href="#">page 12</a>). You will find the DSN number on the label.</p>

If the problem persists, you can refer to the Frequently Asked Questions (FAQ) section on our website, or email or call our technical support:

Website: [www.tricklestar.com](http://www.tricklestar.com)

Email: [customer.service@tricklestar.com](mailto:customer.service@tricklestar.com)

Toll Free: 1-888-700-1098

## Legal

### **FCC STATEMENT**

This equipment has been tested and found to comply with the limits for a Class B digital device, pursuant to Part 15 of the FCC Rules. These limits are designed to provide reasonable protection against harmful interference in a residential installation. This equipment generates uses and can radiate radio frequency energy and, if not installed and used in accordance with the instructions, may cause harmful interference to radio communications. However, there is no guarantee that interference will not occur in a particular installation. If this equipment does cause harmful interference to radio or television reception, which can be determined by turning the equipment off and on, the user is encouraged to try to correct the interference by one or more of the following measures:

- Reorient or relocate the receiving antenna.
- Increase the separation between the equipment and receiver.
- Connect the equipment into an outlet on a circuit different from that to which the receiver is connected.
- Consult the dealer or an experienced radio/TV technician for help.

This device complies with part 15 of the FCC Rules. Operation is subject to the following two conditions:

(1) This device may not cause harmful interference, and (2) this device must accept any interference received, including interference that may cause undesired operation.

Changes or modifications not expressly approved by the party responsible for compliance could void the user's authority to operate the equipment.



## **IC STATEMENT**

This device complies with Industry Canada's licence-exempt RSSs. Operation is subject to the following two conditions:

- (1) This device may not cause interference; and
- (2) This device must accept any interference, including interference that may cause undesired operation of the device.

Le présent appareil est conforme aux CNR d'Industrie Canada applicables aux appareils radio exempts de licence. L'exploitation est autorisée aux deux conditions suivantes : (1) l'appareil ne doit pas produire de brouillage, et (2) l'utilisateur de l'appareil doit accepter tout brouillage radioélectrique subi, même si le brouillage est susceptible d'en compromettre le fonctionnement.

## **RF EXPOSURE INFORMATION**

The distance between user and device should be no less than 8 inches.

la distance entre l'utilisation et l'appareil ne doit pas être inférieure à 8 pouces.



## Warranty

### **THREE-YEAR LIMITED PRODUCT WARRANTY**

TrickleStar Inc. (“TrickleStar”), of 251 Little Falls Drive, Wilmington, DE 19808 warrants to the purchaser this TrickleStar TS2501 Wi-Fi Smart Thermostat (“Product”) will be free from defects in materials and workmanship for a period of three (3) years (“Warranty Period”) from the date of purchase, under normal use and service, and provided the Product is installed and used according to manufacturer’s instructions.

If the Product fails to conform to this Limited Warranty during the Warranty Period, TrickleStar at its sole discretion, will either:

- (a) repair or replace any defective Product or component. The repair or replacement may be made with a new or refurbished Product or components; or
- (b) accept the return of the Product and refund the money paid by the original purchaser for the Product.

If the Product or a component incorporated within is no longer available, TrickleStar at its sole discretion, may replace the Product with a similar product of similar function. This is your sole and exclusive remedy for breach of this Limited Warranty.

Any Product that has either been repaired or replaced under this Limited Warranty will be covered by the terms of this Limited Warranty for the longer of: (a) ninety (90) days from the date of delivery of the repaired Product or replacement Product; or (b) the remaining Warranty Period.

This Limited Warranty is transferable from the original purchaser to subsequent owners, but the Warranty Period will not be extended in duration or expanded in coverage for any such transfer. A proof-of-purchase is required from the owner for TrickleStar to provide a replacement and/or repaired Product.





## HOW TO CLAIM UNDER THIS LIMITED WARRANTY

Before making a claim under this Limited Warranty, the owner of the Product must

- (a) notify TrickleStar of the intention to claim by visiting [TrickleStar.com/support](http://TrickleStar.com/support) during the Warranty Period and providing a description of the alleged failure; and
- (b) comply with TrickleStar's return shipping instructions.

TrickleStar will have no warranty obligations to a returned Product if it determines, in its reasonable discretion after examining of the returned Product, that the Product is an Ineligible Product (defined below). TrickleStar will bear all costs of return shipping to owner and will reimburse any shipping costs incurred by the owner, except to any Ineligible Product, for which the owner will bear all shipping costs.

## WHAT THIS LIMITED WARRANTY DOES NOT COVER

This Limited Warranty does not cover the following (collectively "Ineligible Products"):

- (i) Products that have been subject to: (a) modifications, alterations, tampering, or improper maintenance or repairs; (b) handling, storage, installation, testing, or use, not in accordance with the Installation Manual or other instructions provided by TrickleStar; (c) abuse or misuse of the Product; (d) breakdowns, fluctuations, or interruptions in electric power or telecommunications network; or (e) Acts of God, including but not limited to lightning, flood, tornado, earthquake, or hurricane;
- (ii) Any non-TrickleStar branded products, even if packaged or sold with TrickleStar Product.
- (iii) This Limited Warranty does not cover consumable parts, including batteries, unless damage is due to defects in materials or workmanship of the Product, or software (even if packaged or sold with the Product).
- (iv) Installation or dismantling costs.

## DISCLAIMER OF WARRANTIES

EXCEPT AS STATED ABOVE IN THIS LIMITED WARRANTY, AND TO THE MAXIMUM EXTENT PERMITTED BY APPLICABLE LAW, TRICKLESTAR DISCLAIMS ALL EXPRESS, IMPLIED, AND STATUTORY WARRANTIES AND CONDITIONS WITH RESPECT TO THE PRODUCT, INCLUDING THE IMPLIED WARRANTIES OF MERCHANTABILITY AND FITNESS FOR A PARTICULAR PURPOSE. TO THE MAXIMUM EXTENT PERMITTED BY APPLICABLE LAW, TRICKLESTAR ALSO LIMITS THE DURATION OF ANY APPLICABLE IMPLIED WARRANTIES OR CONDITIONS TO THE DURATION OF THIS LIMITED WARRANTY.



## **LIMITATION OF DAMAGES**

In addition to the above warranty disclaimers, in no event will TrickleStar be liable for any consequential, incidental, exemplary, or special damages, including any damages for lost data or lost profits, arising from or relating to this limited warranty or the Product. TrickleStar's total cumulative liability arising from or related to this limited warranty or the Product will not exceed the amount paid for the Product by the original purchaser.

## **LIMITATION OF LIABILITY**

The TrickleStar website, TrickleStar Portal, and/or TrickleStar App (iOS and Android) online services ("Services") provide information ("Product Information") on TrickleStar Products or other peripherals connected to your products ("Product Peripherals"). The type of Product Peripherals that may be connected to your product may change from time to time. Without limiting the generality of the disclaimers above, all Product Information is provided for your convenience, "as is", and "as available". TrickleStar does not represent, warrant, or guarantee that Product Information will be available, accurate, or reliable; or that Product Information or use of the Services or Product will provide safety in your premises. You will use all Product Information, Services, and the Product at your own discretion and risk. You will be solely responsible for (and TrickleStar disclaims) any and all losses, liabilities, or damages, including those to your wiring, fixtures, electricity, home, office, product, product peripherals, computer, mobile device, and all other items and pets in your home, resulting from your use of TrickleStar's Product Information, Services, or Product. Product Information provided by the Services is not intended to be a substitute for direct means of obtaining the information. For example, a notification provided through the Services is not intended to substitute the audible and visible indications in the premises and on the Product.

## **JURISDICTION**

This Limited Warranty shall be governed by the laws of the state of Delaware.

## **YOUR RIGHTS AND THIS LIMITED WARRANTY**

This Limited Warranty gives you specific legal rights. You may also have other legal rights that vary by state or jurisdiction. Likewise, some of the limitations in this Limited Warranty may not apply in certain states or jurisdictions. The terms of this Limited Warranty will apply to the extent permitted by applicable law.

## **CHANGES TO THIS POLICY**

TrickleStar may revise this Policy from time to time. The latest version of the policy will govern our use of your information and will always be published on the TrickleStar website ([www.TrickleStar.com](http://www.TrickleStar.com)). By continuing to access or by using the TrickleStar website, TrickleStar Portal and/or TrickleStar App (iOS or Android) after those changes become effective, you agree to be bound by the revised Policy.



**HOW TO CONTACT US IF YOU WISH TO DISCUSS THIS POLICY**

If you wish to discuss any aspect of this policy, contact us by email at: [customer.service@tricklestar.com](mailto:customer.service@tricklestar.com).



For technical support, go to:  
Website: [www.tricklestar.com](http://www.tricklestar.com)  
Email: [customer.service@tricklestar.com](mailto:customer.service@tricklestar.com)  
Toll Free: 1-888-700-1098

Patent No. Des. D957,965

© 2022 TrickleStar Inc. All rights reserved.

TrickleStar® is a registered trademark of TrickleStar Ltd. All other trademarks are the property of their respective owners. The information in this document is subject to change without notice. TrickleStar assumes no responsibility for any errors that may appear in this document.